

OPPLE

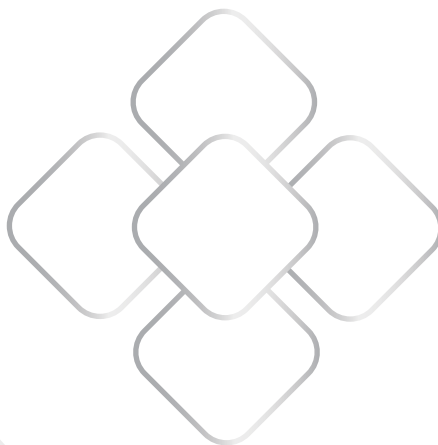
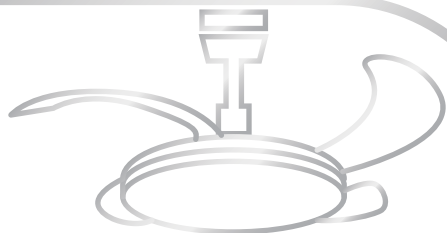

LUMINAIRES CATALOGUE 2022/2023

CONSUMER

OPPLE.COM



OPPLE 欧普照明



About OPPLE

OPPLE Lighting Co., Ltd, a leading lighting company in China, is rapidly expanding in more than 70 countries worldwide with 6,000 employees. It boasts the largest distribution network in China and over 150,000 sales terminals worldwide including over 3,000 branded shops. OPPLE has a strong focus on innovation with over 4,000 patents, backed by its 2 large ISO-certified manufacturing facilities and an R&D team of over 400 engineers.

Furthermore, the Company has set up a professional laboratory up to international standards--the Wujiang laboratory. Owning 10 professional branch testing labs, it has been awarded the ISO17025 national certification by CNAS/ILAC (International Laboratory Accreditation Cooperation), and also has been titled the TUV international accreditation laboratory, whose data provided is widely recognized.

Now we hold not only the facility certificates such as SA 8000: Social Accountability, ISO9001: Quality management and ISO14000: Environment management, etc., but also various international product quality certificates: CB, CE, GS and special ones for different countries: RCM(SAA), BIS, SASO, TISI, SIRIM, SNI, NEA etc. With the local presence of experienced and skilled OPPLE staff, you can now take full advantage of our innovative products.

In September 2009, OPPLE became the official exhibitor of Shanghai Expo Private Corporate United Pavilion, OPPLE provided excellent lighting solutions for the Pavilion, and for many customers worldwide as well.

R&D Center

OPPLE Lighting holds a professional R&D team with more than 300 members, over 80 of whom hold a master's degree or above, a post-doctoral research station, and 10 Professional R&D Labs in Shanghai, Zhongshan, Suzhou and Europe. Most of the lab staff have MNC working experience and extensive research backgrounds, and more than 26% hold master's or PhD degrees.

The two R&D centers have been establishing strategic partnerships with many world-leading organizations such as Huawei, oneTLED and Zigbee.



Research & Development

15

Professional R&D Labs

300+

Professional R&D staff



24%

Master's Degree above

48%

Bachelor's Degree

15M+ USD

Annual R&D investment

4,000+

Issued and pending patents

400+

Top engineers, designers & technicians



Main Production Facilities



Wujiang

Area: **600,000+ m²**
Staff: Nearly **2,000**

Production line:

LED luminaires (downlights/spotlights/panels...)



Zhongshan

Area: **52,000+ m²**
Staff: Nearly **2,500**

Production line:

LED luminaires (light sources/battens/ceiling lamps/...);
electricals appliances



Automated production line

In 2015, the first automated production line was built to greatly increase production efficiency and capacity.



Industry 4.0

In 2016, the first robot arm was used for automatic inspection of molds, marking the official introduction of Industry 4.0.





Lighting Design Team Standard Work Process

For different projects, designers will support to multiple degrees to help control the deviation and implementation of the results at each phase.

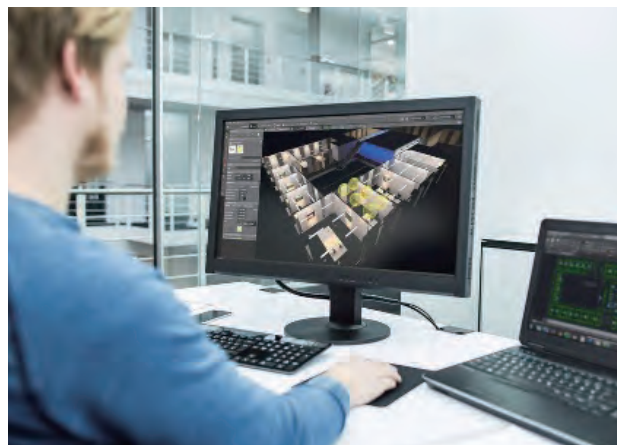
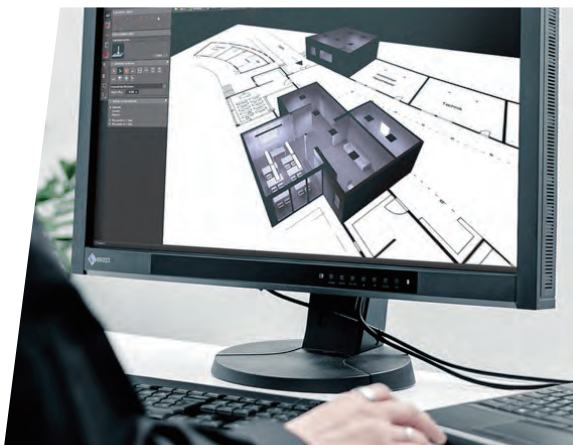
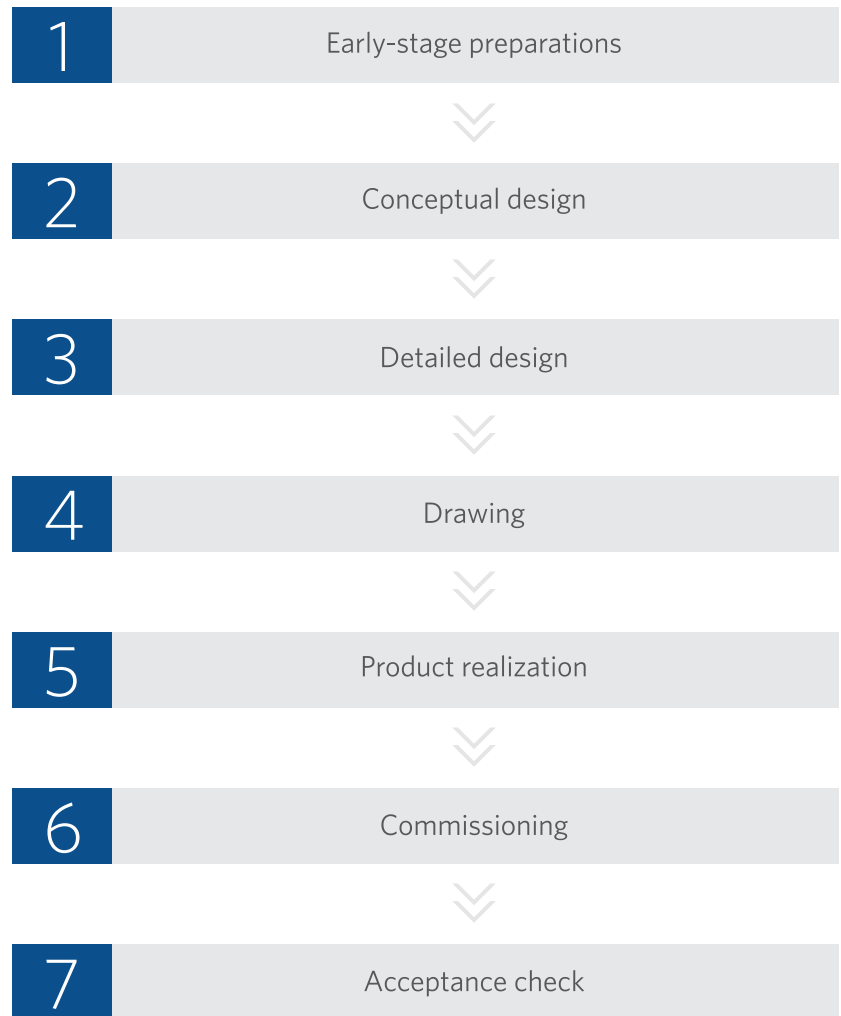

Product Testing & Certification

The company has the most advanced product testing system in the industry, and maintain long-term in-depth cooperation and technical communication with multiple authoritative testing and certification third-parties. At the same time, the company has a national-level lighting laboratory (CNAS certified) in line with ISO/IEC17025. In the production of finished luminaires, a comprehensive quality inspection and monitoring process is set up for quality control.



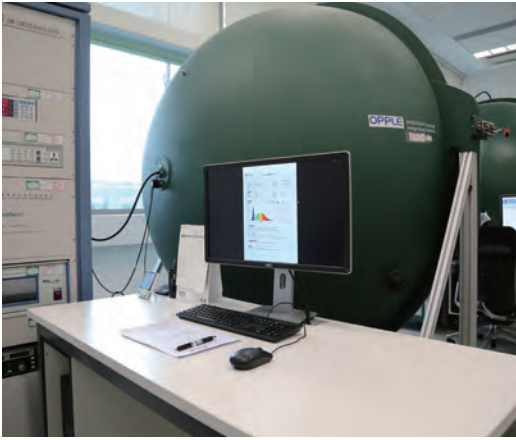

On-site Technical Support

The project is equipped with a professional on-site technical support team, tracking and providing assistance starting from the early stage of the plan, to ensure the proper installation of the products and solve emergencies on the spot, so as to guarantee the final effect and progress of the project.





Customer Service

A full on-site customer services is provided on request of customer, including professional installation instructions and corresponding after-sales services.



Business Scope

Founded in 1996, OPPL has been engaged in R&D, production, distribution and after-sales services of lighting sources, lighting fixtures and controls, operating in over 70 countries and regions in Asia Pacific, Europe, Middle East and South Africa. With a powerful marketing team and a well-established worldwide marketing network, it now has over 150,000 sales points



31-40

Ceiling Lamp
-COMPACT

Diamond
Star-Crown II
Star-Sunlight II
White
Detector

53-60

Ceiling Lamp
-LIVING ROOM

Cloud II
WindyS

61-64

Mirror Lamp
-BATHROOM

Alice
William
Xiaobai

01-14

About OPPLE

41-52

Ceiling Lamp
-BEDROOM

Halo
Star Attic
Prism
White
Star Diamond
Rosy
Hikari
Smart Twinkle

Content

65-74

Table Lamp
-READING & WORKING

Pipe II
Reader
Toronto
Lotus

79-82

Others

Germicidal lamp

89-92

Breaker

Breaker-ZB series circuit breaker

83-88

Switch and Socker

Switch & Socket F01&F02

75-78

Wall Lamp
-OPTIMAL AMBIENCE

Peacock

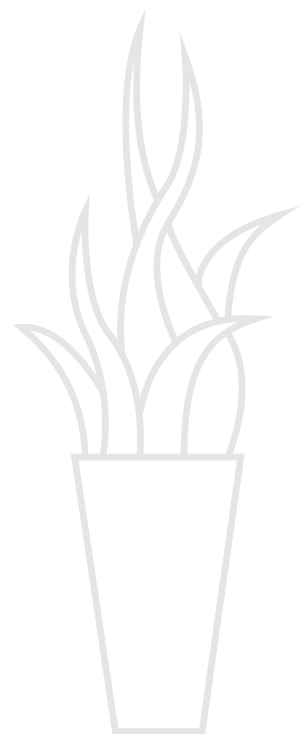



Ceiling Lamp Series	Power (W)	Lumen	Life	Dimension (mm)	Dust & Water Proof	Sensor	Dimmable / Tunable	Remote Control	Flicker Free	Never Fading
---------------------	-----------	-------	------	----------------	--------------------	--------	--------------------	----------------	--------------	--------------



6-12 W	Up to 850lm	20000 hrs	Φ180-Φ230 180*180	IP44	✗	✗	✗	✓	✓
--------	-------------	-----------	----------------------	------	---	---	---	---	---

Diamond

P₀₃₃₋₀₃₄



9,6w	800lm	20000 hrs	Φ278	IP20	✗	✗	✗	✓	✓
------	-------	-----------	------	------	---	---	---	---	---

Star-Crown II

P₀₃₅₋₀₃₆



9,6w	800lm	20000 hrs	Φ260	IP20	✗	✗	✗	✓	✓
------	-------	-----------	------	------	---	---	---	---	---

Star-Sunlight II

P₀₃₅₋₀₃₆



7,5-23 W	Up to 1900lm	20000 hrs	Φ220-Φ335 218*218 300*300	IP20	✗	✗	✗	✓	✓
----------	--------------	-----------	---------------------------------	------	---	---	---	---	---

White

P₀₃₇₋₀₃₈







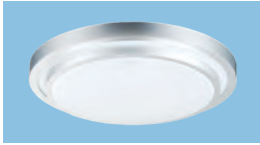

10w	800lm	20000 hrs	Φ260	IP20	Motion / Voice	✗	✗	✓	✓
-----	-------	-----------	------	------	----------------	---	---	---	---

Detector

P₀₃₉₋₀₄₀

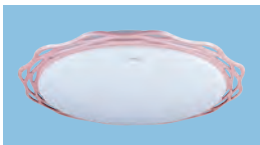

Ceiling Lamp Series	Power (W)	Lumen	Life	Dimension (mm)	Dust & Water Proof	Sensor	Dimmable / Tunable	Remote Control	Flicker Free	Never Fading
 Halo	16w	1300 lm	20000 hrs	Ø345	IP20	✗	✗	✗	✓	✓
 Star-Attic	16w	1200 lm	20000 hrs	Ø380	IP20	✗	✗	✗	✓	✓
 Prism	18w	1300 lm	20000 hrs	Ø380	IP20	✗	✗	✗	✓	✓
 White	23-38 W	Up to 3000lm	20000 hrs	Ø335-Ø410	IP20	✗	✗	✗	✓	✓
 Star-Diamond	18-48 W	Up to 3700lm	20000 hrs	Ø272-Ø480	IP20	✗	Optional	✗	✓	✓
 Rosy	22w	1800 lm	20000 hrs	Ø420	IP20	✗	✓	✗	✓	✓
 Hikari	55w	3600 lm	20000 hrs	Ø616	IP20	✗	✓	✗	✓	✓
 Smart Twinkle	36w	1600 lm	15000 hrs	518*498	IP20	✗	✓	✓	✓	✓

P₀₄₃₋₀₄₄

P₀₄₃₋₀₄₄

P₀₄₃₋₀₄₄

P₀₄₅₋₀₄₈

P₀₄₅₋₀₄₈

P₀₄₉₋₀₅₀

P₀₄₉₋₀₅₀

P₀₅₁₋₀₅₂





Ceiling Lamp Series	Power (W)	Lumen	Life	Dimension (mm)	Dust & Water Proof	Sensor	Dimmable / Tunable	Remote Control	Flicker Free	Never Fading
---------------------	-----------	-------	------	----------------	--------------------	--------	--------------------	----------------	--------------	--------------



92/144 W	Up to 10300 lm	20000 hrs	650*650 990*650	IP20	✗	✓	✗	✓	✓
----------	----------------	-----------	--------------------	------	---	---	---	---	---

Cloud II

• P055-056



54-94W Lamp 24-54W Fan 30-40W	Up to 3800lm	15000 hrs	Φ408-505 Sweep Φ910-1066	IP20	✗	Optional	✓	✓	✓
---	--------------	-----------	--------------------------------	------	---	----------	---	---	---

WindyS

• P057-060



Mirror Lamp Series	Power (W)	Lumen	Life	Length*Width (mm)	Material	Flicker Free	Tube Adjustable
--------------------	-----------	-------	------	-------------------	----------	--------------	-----------------

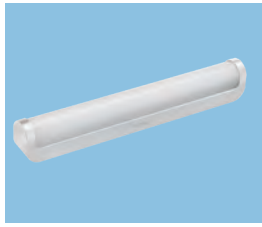

9w	600lm	20000 hrs	440*70	Al+PC	<input checked="" type="checkbox"/>	<input type="checkbox"/>
----	-------	-----------	--------	-------	-------------------------------------	--------------------------

Alice

P063-064

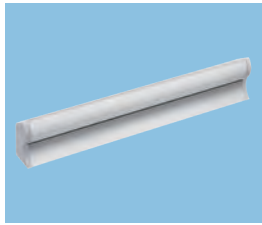

9w	600lm	20000 hrs	470*80	Al+PC	<input checked="" type="checkbox"/>	<input checked="" type="checkbox"/>
----	-------	-----------	--------	-------	-------------------------------------	-------------------------------------

William

P063-064



10w	650lm	20000 hrs	586*64	PC+PMMA	<input checked="" type="checkbox"/>	<input type="checkbox"/>
-----	-------	-----------	--------	---------	-------------------------------------	--------------------------

Xiaobai

P063-064



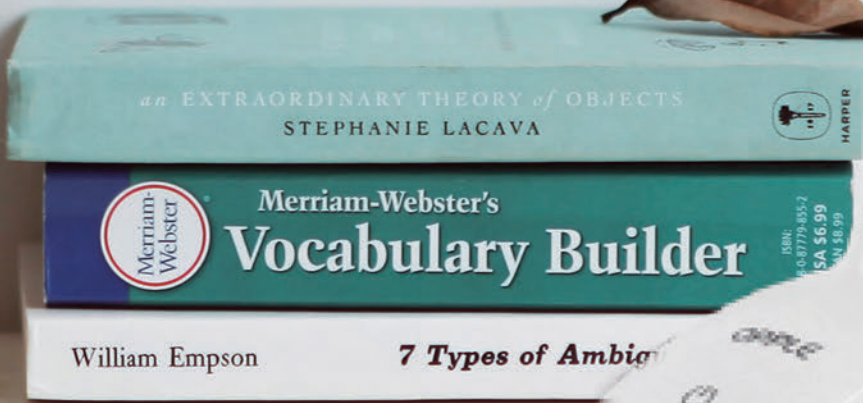

Table Lamp Series	Power (W)	Lumen	Life	Rated Voltage	Plug	Desktop Illumination	Dimmable	Battery	Flicker Free
-------------------	-----------	-------	------	---------------	------	----------------------	----------	---------	--------------



4.8w	100lm	20000 hrs	DC 5V	USB	★	3-Step	Large Capacity	✓
------	-------	-----------	-------	-----	---	--------	----------------	---

Pipe II

• P₀₆₇₋₀₆₈



5w	200lm	20000 hrs	DC 5V	USB	★★	3-Step	Large Capacity	✓
----	-------	-----------	-------	-----	----	--------	----------------	---

Reader

• P₀₆₉₋₀₇₀



7w	≥450 lm	20000 hrs	220-240V	Type C	★★★	Stepless	✗	✓
----	---------	-----------	----------	--------	-----	----------	---	---

Toronto

• P₀₇₁₋₀₇₂





Night Light Series	Power (W)	Lumen	Life	Power Supply	Automatic On/Off	Installation
--------------------	-----------	-------	------	--------------	------------------	--------------



0.3w

14lm

15000 hrs

DC4.5V
3 X AAA Battery



4 in 1
1. Portable 3. Pastable
2. Magnetic 4. Hanging

Lotus

P₀₇₃₋₀₇₄

Wall Lamp Series	Power (W)	Lumen	Life	Light Color	Special Lens Design
------------------	-----------	-------	------	-------------	---------------------



5.7w

250lm

15000 hrs

Colorful
+ White

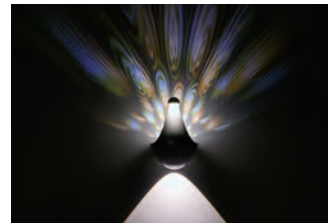

Peacock

P₀₇₇₋₀₇₈

Germicidal Lamp Series	Power (W)	UV Intensity	Bactericidal Rate	Bactericidal Range	Sensor	Control
------------------------	-----------	--------------	-------------------	--------------------	--------	---------



38w

>150 uW/cm²

99.99%

Up to 40 m²

Motion Sensor

1. Remote Control
2. Time Settable

UV-Germicidal Lamp

P₀₈₁₋₀₈₂



Switch and Socket Series	High Capacity	Dimension (mm)	Safety Shutters	850° Anti-flaming	Switching Times	Plugging Times
--------------------------	---------------	----------------	-----------------	-------------------	-----------------	----------------



F01

16A	120*70	✓	✓	40000	5000
-----	--------	---	---	-------	------

• P085-086



F02

16A	86*88	✓	✓	40000	5000
-----	-------	---	---	-------	------

• P087-088



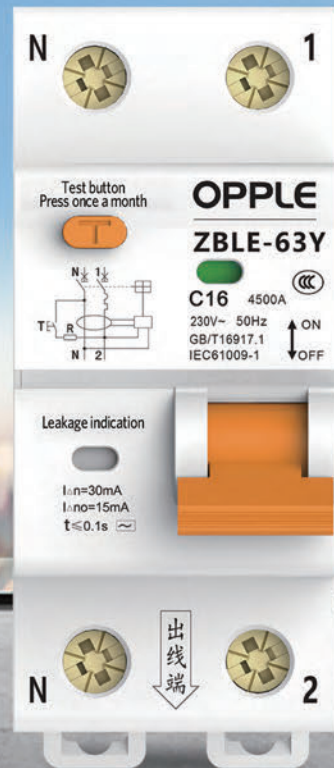
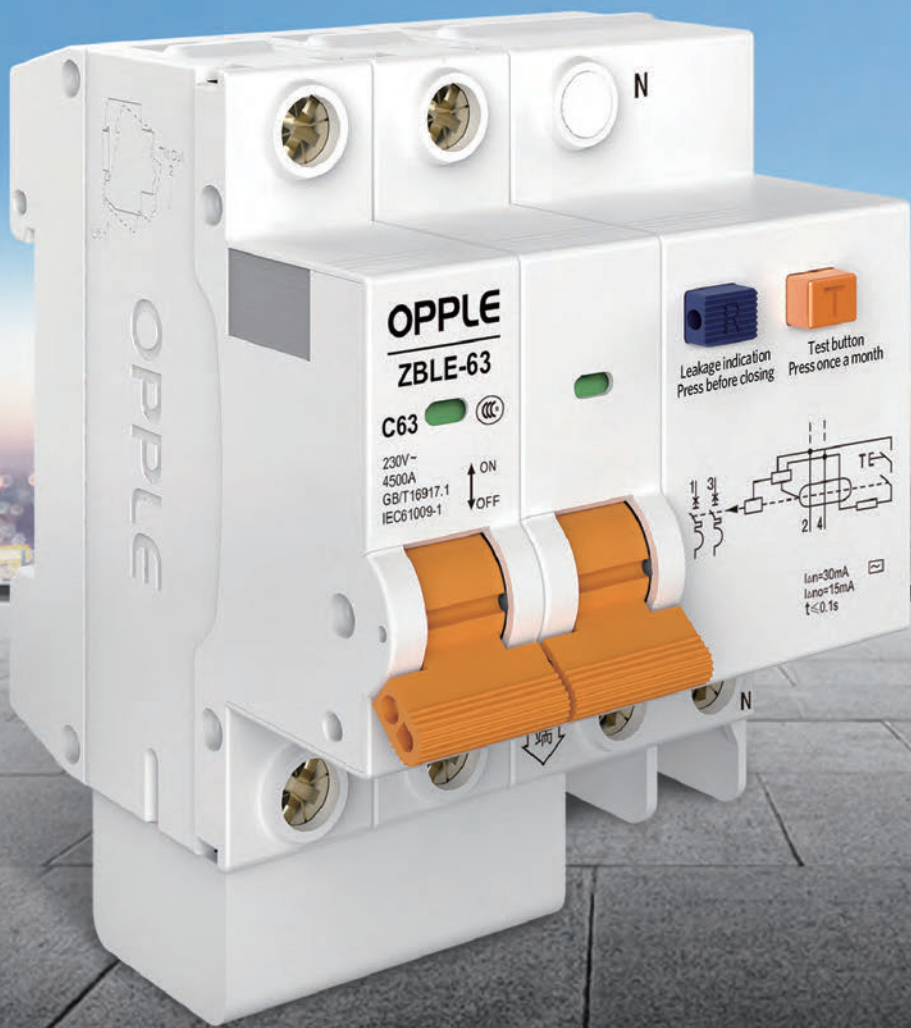

Breaker Series	Rated Current	Rated Service Breaking Capacity	Number of Protected Poles	Switching Times
----------------	---------------	---------------------------------	---------------------------	-----------------



10~63 A

4500A

1P-4P

10000

ZB

P091-092



CEILING LAMP
-CAMPACT







LED

IP44

IP44 Diamond

Order Name	HC180-D0.2*30 Diamond	HC230-D0.2*60 Diamond
Power (W)	6W	12W
Color temperature (K)	3000/5700K	3000/5700K
Dimensions(mm)	Φ 180*37	Φ 230*40
Material	PMMA+PC	PMMA+PC
Luminous Flux	400	850
Area(m ²)	2-4	5-8

LED

IP44

IP44 Diamond

Order Name	HC1818-D0.2*42 Diamond
Power (W)	9W
Color temperature (K)	3000/5700K
Dimensions(mm)	180*180*37
Material	PMMA+PC
Luminous Flux	540
Area(m ²)	3-5





LED

Star-Crown II

Order Name	HC260 9.6W Star-Crown II
Power (W)	9,6W
Color temperature (K)	3000K/5700K
Dimensions(mm)	Φ278*84
Material	PMMA+PC
Luminous Flux	800
Area(m ²)	8-12

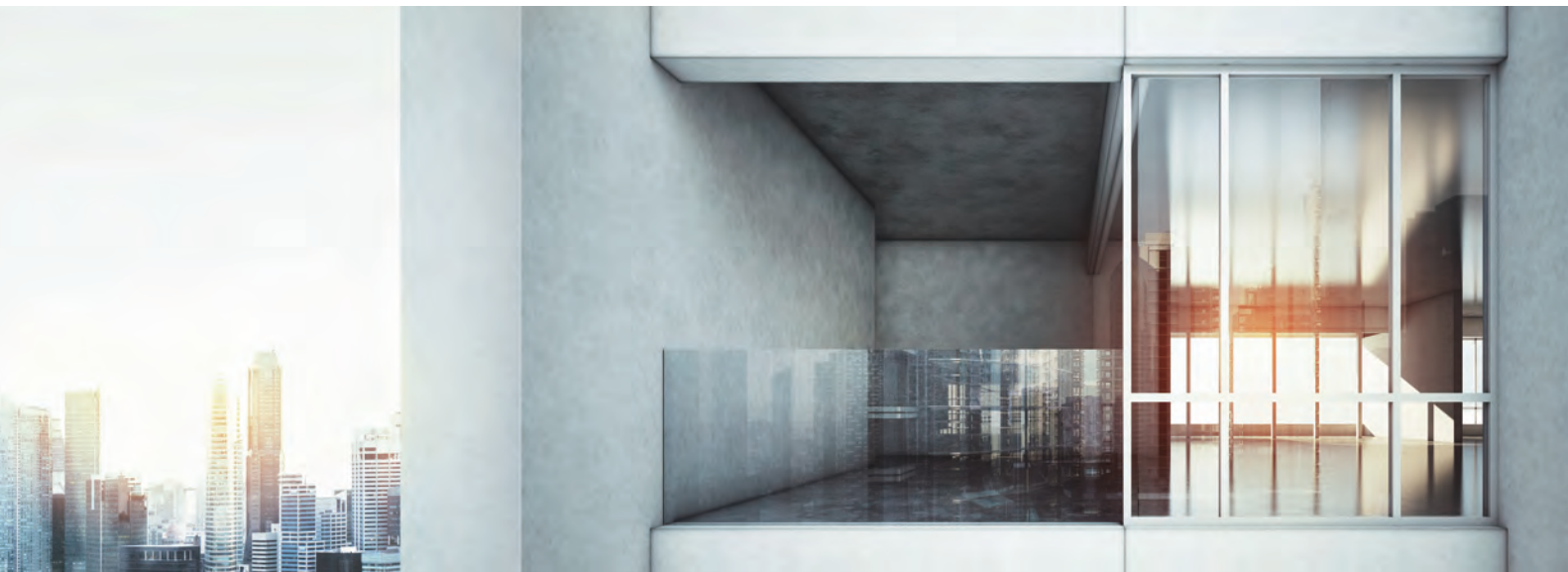

LED

Star-Sunlight II

Order Name	HC260 9.6W Star-Sunlight II
Power (W)	9,6W
Color temperature (K)	5700K
Dimensions(mm)	Φ278*84
Material	PMMA+PC
Luminous Flux	800
Area(m ²)	8-12







LED

White

Order Name	LED HC2020	LED HC3030
Power (W)	7,5W White	15W White
Color temperature (K)	4000/5700K	2700/4000/5700K
Dimensions(mm)	218*218*80	300*300*87
Material	PMMA+Steel	PMMA+Steel
Luminous Flux	500	1200



LED

White

Order Name	LED HC200	LED HC260	LED HC350
Power (W)	10W White	18W White	23W White
Color temperature (K)	5700K	5700K	5700K
Dimensions(mm)	Φ200*48	Φ272*60	Φ335*66
Material	PC	PC	PC+Steel
Luminous Flux	900	1500	1900
Area(m ²)	8-12	8-12	8-12



LED

White

Order Name	HC350 18W AU Dim
Power (W)	18W
Color temperature (K)	3000/4000/5000K
Dimensions(mm)	Φ339*105
Material	PMMA
Luminous Flux	1600(10%-100%)





LED

SENSOR LAMP

Detector

Order Name	HC260-D0.5-Detector-Mic-10W	HC260-D0.5-Detector-Voice-10W
Power (W)	10W	10W
Color temperature (K)	5700K	4000/5700K
Dimensions(mm)	Φ 260X80	Φ 260X80
Material	PMMA+Steel	PMMA+Steel
Luminous Flux	800	800
Control	Microwave	Voice



CEILING LAMP
-BEDROOM







LED

Halo

Order Name	LED HC350 16W Halo
Power (W)	16W
Color temperature (K)	4000/5700K
Dimensions(mm)	Φ 345*98
Material	PMMA+Metal
Luminous Flux	1300
Area(m ²)	8-12



LED

Star-Attic

Order Name	HC350 16W Star-Attic
Power (W)	16W
Color temperature (K)	4000/5700K
Dimensions(mm)	Φ 380*85
Material	PMMA+Metal
Luminous Flux	1200
Area(m ²)	12-16

LED

Prism

Order Name	HC380 18W Prism
Power (W)	18W
Color temperature (K)	4000
Dimensions(mm)	Φ 380*90
Material	PMMA+Metal
Luminous Flux	1300
Area(m ²)	8-12



Shinning like Starry Sky



Brighter Than Ever



Uniform Light



Eye Care



Ra>80



Slim Design





LED Ceiling Lamp_ **Star Diamond & White**



UNIFORM LIGHT

- > Special 155° wide angle and bigger size optical lens design
- > Unique Optical PMMA Cover, no fading and crispness

Comparison of various cover materials		
Optical PMMA	Non fragile plastic PVC	Ordinary plastic PS
No yellowing and crispness 	Prone to yellowing 	Prone to yellow embrittlement 
High light transmittance	Low light transmittance	Poor light transmittance
UV resistance to oxidation	Relatively easy to oxidize	Extremely easy to oxidize

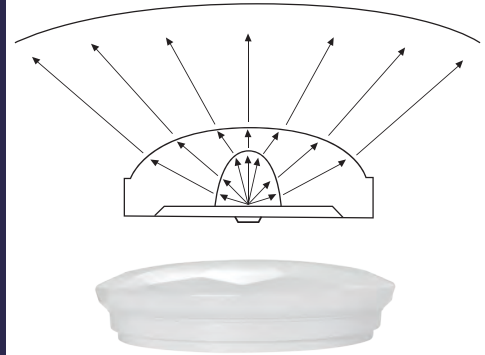

BRIGHTER THAN EVER

Base Range	Market Typical	New GEN	Lumen increase
200	4.5W, 300lm	10W, 900lm	Up to 3 times
260	10W, 800lm	18W, 1500lm	Up to 88%
350	16W, 1300lm	23W, 1900lm	Up to 46%
420	23W, 1900lm	38W, 3000lm	Up to 58%



EYE CARE

RG0 No Blue Light

Flicker Free



BLUE LIGHT HAZARD CLASS	
Class	Safety
RG 0 No Hazard	No photobiological hazard under the limit condition 
RG 1 Low Hazard	Not cause any photobiological hazard under Normal use
RG 2 Moderate hazard	No adverse reaction to strong light and temperature

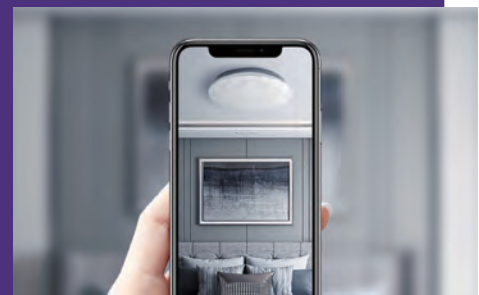

SLIM DESIGN

72mm

Beauty and Space saving with up to **15%-40%** thickness reduction VS last generation

48mm





LED

White

Order Name	LED HC350 23W White	LED HC420 38W White
Power (W)	23W	38W
Color temperature (K)	5700K	5700K
Dimensions(mm)	Φ335X66	Φ410X72
Material	PC+Steel	PC+Steel
Luminous Flux	1900	3000



LED

Star Diamond

Order Name	LED HC260 18W Star Diamond	LED HC350 23W Star Diamond	LED HC420 38W Star Diamond	LED HC480 48WDIM Star Diamond
Power (W)	18W	23W	38W	48W
Color temperature (K)	5700K	5700K	5700K	2700/5700K
Dimensions(mm)	Φ272X66	Φ335X72	Φ410X74	Φ480X86
Material	PC	PC+Steel	PC+Steel	PC+Steel
Luminous Flux	1500	1900	3000	3700

DIMMABLE



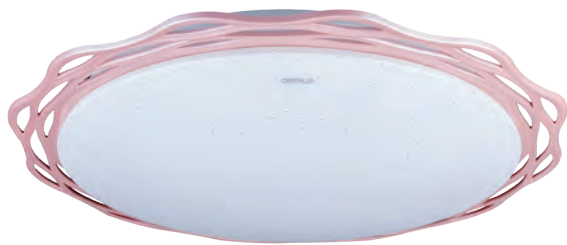

LED

Rosy

Order Name	LED HC420 22W 3000/4500K Rosy
Power (W)	22W
Color temperature (K)	3000/4500K
Dimensions(mm)	Φ 420*85
Material	PMMA+Steel
Luminous Flux	1800



LED

Hikari

Order Name	HC550 55W Dim Hikari
Power (W)	55W
Color temperature (K)	3000/4000/5700K
Dimensions(mm)	Φ 616*92
Material	PMMA+Metal
Luminous Flux	3600
Area(m ²)	12-16



Twinkle Twinkle

little star
How I wonder what you are!



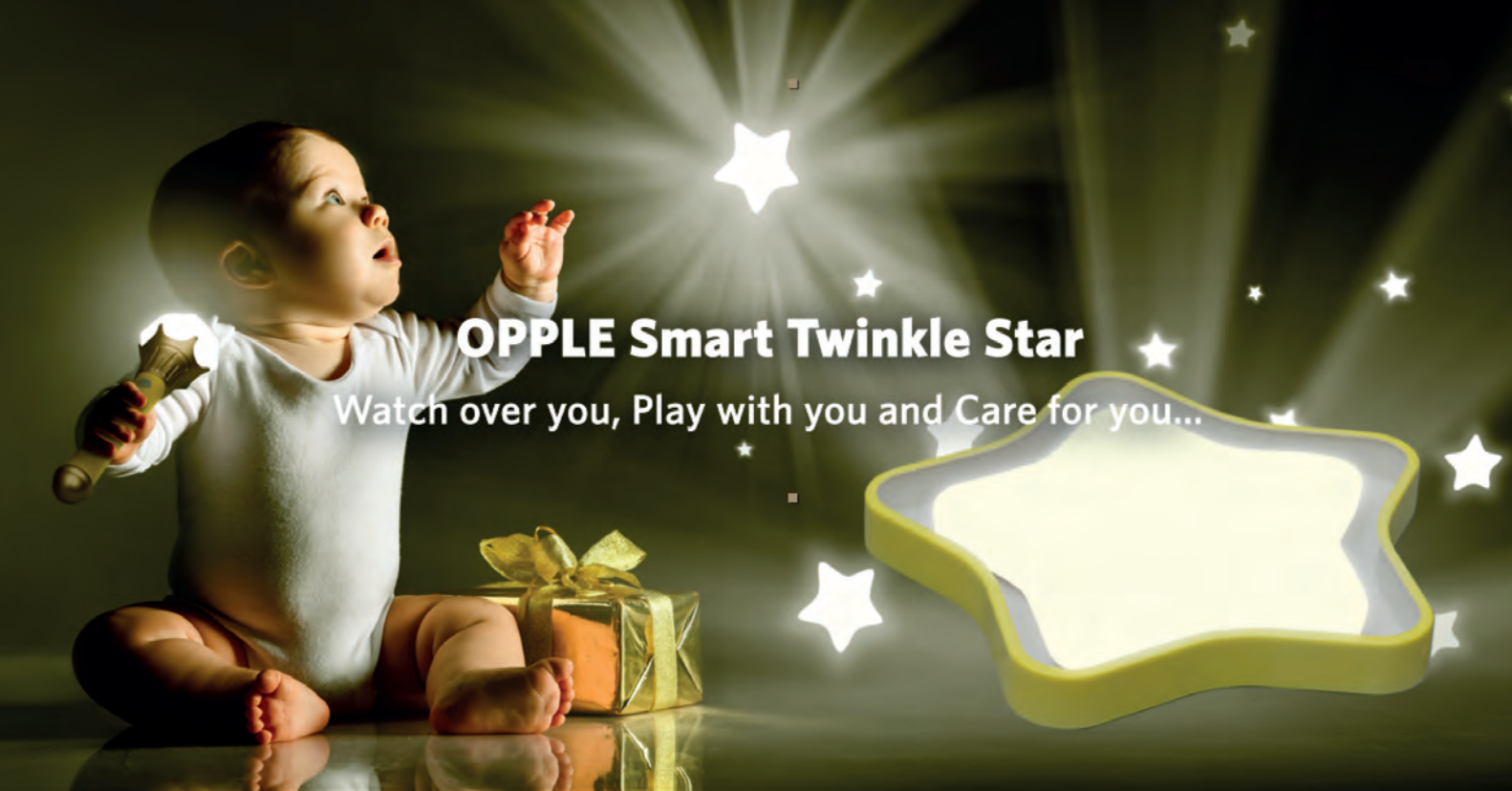

OPPLE Smart Twinkle Star

Watch over you, Play with you and Care for you...



Smart with Magic Wand

By tapping the magic wand on the pallet, or tap it on anything...
The rim of the star will shine in the color of whatever the wand touches.



LED

Smart Twinkle

Order Name	LED IC518 Dim 5700K Smart Twinkle
Power (W)	36W
Color temperature (K)	5700K+RGB
Dimensions(mm)	518*498*105
Material	PMMA+ABS
Luminous Flux	1600
Area(m ²)	12-16

CEILING LAMP
-LIVING ROOM









LED

DIMMABLE

Cloud II

Order Name	LED HC6565	LED HC9965
	92W Cloud II	144W Cloud II
Power (W)	92W	144W
Color temperature (K)	3000K+5700K	3000K+5700K
Dimensions(mm)	650*650*140	990*650*140
Material	PMMA+Metal	PMMA+Metal
Luminous Flux	6500	10300
Area(m ²)	25-35	30-40





RADIANT LIKE DIAMOND



0.5 μ m
Cutting Precise Lens



4 Axis
Simultaneous



Smart Control



No Blue Light



Flicker Free



↑ 28% Higher lumen

0.5μm Cutting Precise Lens Design

- > Unique wide angle optical lens design of pyramid and double free form surface with 0.5μm cutting Precise Lens design
- > The unique double free-form surface design makes the light more uniform and more comfortable after the secondary refraction of the lens.
- > The rectangular pyramid with special angle control at the lens bottom can gather stray light and refract it out evenly to improve the overall brightness and uniformity.
- > 28% lumen increase VS last generation
- > 23% lm/W increase VS last generation

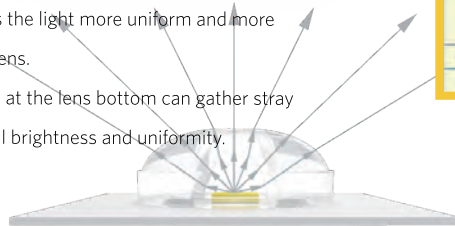

Comparison of various cover materials		
Optical PMMA	Non fragile plastic PVC	Ordinary plastic PS
No yellowing and craziness	Prone to yellowing	Prone to yellow embrittlement
High light transmittance	Low light transmittance	Poor light transmittance
UV resistance to oxidation	Relatively easy to oxidize	Extremely easy to oxidize

Unique Optical PMMA Cover

The cover is made of high quality Mitsubishi acrylic pure material, OPPLÉ exclusive cover recipe, high light transmittance with comfortable and soft light. Light and solid, not easy to turn yellow and not fade, durable.



Flexible, Stable & Smooth

4 Axis Simultaneous Design

- > Reduce air loss during operation
- > Stable operation with free retracting vanes
- > Flexible, stable and smooth

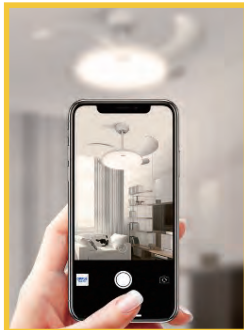

Eye protection with more safe and comfortable light

- > RG0 rating for retina protection
- > Flicker free
- > No blue light hazard after professional test, and it use PWM dimming technology, healthy eye protection and flicker free, safe and comfortable.



Flicker Free



No Blue Light



Smart with Wireless Remote Control

- > Easy and convenient
- > 3 fan speed, Adjust the wind speed as you like
- > 3 step dimming, Choose as per requirement



3 Fan Speed



3 Step Dimming







LED

DIMMABLE

WindyS

Order Name	LEDFSD-E-Rd420-WindyS White
Power (W)	54W (Lamp 24W/Fan 30W)
Color temperature (K)	5700K
Dimensions(mm)	Φ 408*300
Material	Hardware+PMMA+PC
Luminous Flux	2200
Area(m ²)	8-12

Order Name	LEDFSD-E-Rd420-STEP -WindyS White/Black&White/Gold
Power (W)	66W (Lamp 36W/Fan 30W)
Color temperature (K)	3000K+5700K
Dimensions(mm)	Φ 430*300
Material	Hardware+PMMA+PC
Luminous Flux	3200(MAX)
Area(m ²)	8-12

Order Name	LEDFSD-E-Rd480-STEP -WindyS White/Black/Gold
Power (W)	94W (Lamp 54W/Fan 40W)
Color temperature (K)	3000K+5700K
Dimensions(mm)	Φ 505*300
Material	Hardware+PMMA+PC
Luminous Flux	3800(MAX)
Area(m ²)	12-16



MIRROR LAMP
-BATHROOM



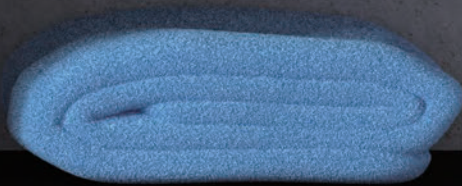
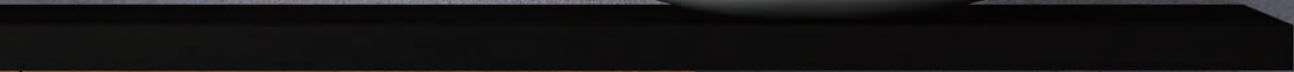





Alice & William

Order Name	LED-HML440-9W-Alice-CT
Power (W)	9W
CCT(K)	4000K
Dimensions(mm)	440*70*50
Material	AL+PC

Order Name	LED-HML470-9W-William-CT
Power (W)	9W
CCT(K)	4000K/6500K
Dimensions(mm)	470*80*41
Material	AL+PC

Features

- Up to 600lm, above 85% high transmittance PC cover
- Reliable oxidation frost silver AL framework
- Flicker Free

Benefits

- High efficiency for higher energy saving standard
- Simple and modern, suitable for all kinds of decoration styles
- Reliable in poor grid environment
- Soft and comfortable light for quality experience



Xiaobai

Order Name	LED HML549 10W 4000K XIAOBAI IBU
Power (W)	10W
CCT(K)	4000K
Dimensions(mm)	586*64*50
Material	Hardware+PMMA

TABLE LAMP
-READING & WORKING



1 CHARGE 3 WEEKS FOR 3 WEEKS

*at 10% lumen output with working 1hr a day



1800
mAh

Last 3 Weeks

RG0

No Blue Light



Flicker Free



Ra > 80



Touch Dimming
Design

1800 mAh

CONVENIENCE AND EASY TO USE

• 1 Charge for 3 weeks

*at 10% lumen output with working 1hr a day



• Multiple ways of use with 360°free adjustment lamp arm



• Clip anywhere with one hand



One hand open and close 45mm maximum clamping thickness



Non-slip design of inner surface of clip

• Charging and plug-in with USB port, use while charging without delay



LED

Pipe II

Order Name	
Power (W)	4.8W
Color temperature (K)	4000K
Dimensions(mm)	121*74*413
Material	ABS+PS
Luminous Flux	100
Battery capacity	1800mAh



3 LEVEL LUMEN OUTPUT WITH TOUCH DIMMING DESIGN



Touch Dimming Design



READING AND WRITING
LEVEL 1- 100% LUMEN OUTPUT



RECREATION
LEVEL 2- 50% LUMEN OUTPUT



NIGHT LIGHT
LEVEL 3- 10% LUMEN OUTPUT

RG0

No Blue Light



EYE CARE



Flicker Free



BLUE LIGHT HAZARD CLASS

Class	Safety
RG 0 No Hazard	No photobiological hazard under the limit condition
RG 1 Low Hazard	Not cause any photobiological hazard under Normal use
RG 2 Moderate hazard	No adverse reaction to strong light and temperature

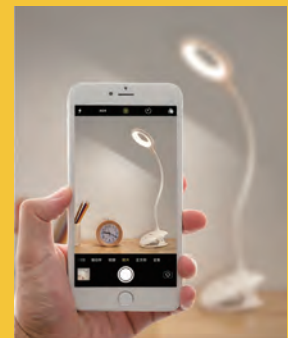





LED

Reader

Order Name	LED MT 5W 4000K Reader
Power (W)	5W
Color temperature (K)	4000K
Dimensions(mm)	280*100*100
Material	Aluminium+PMMA
Luminous Flux	200
Battery capacity	1800mAh







LED

DIMMABLE

Toronto

Order Name	LED HTL 7W Dim 4000K Toronto White	LED HTL 7W Dim 4000K Toronto Black
Power (W)	7W	7W
Color temperature (K)	4000K	4000K
Dimensions(mm)	200*156*450	200*156*450
Material	ABS	ABS
Luminous Flux	≥450	≥450



To be yourself
in the most relaxing state





LED

DIMMABLE

INFRARED SENSOR

Lotus

Order Name	LED-NL-Lotus-WBP (white)
Power (W)	0,3W
Color temperature (K)	3000K
Dimensions(mm)	75*75*18
Material	Metal+PC+PMMA
Luminous Flux	14

WALL LAMP
-OPTIMAL AMBIENCE







Peacock

Order Name	LED HWL 120 5.7W Peacock
Power (W)	5.7W
Color temperature (K)	3000K/4000K/5700K
Dimensions(mm)	Φ120*117.5
Material	Die-cast Aluminum+PC+Glass
Luminous Flux	250

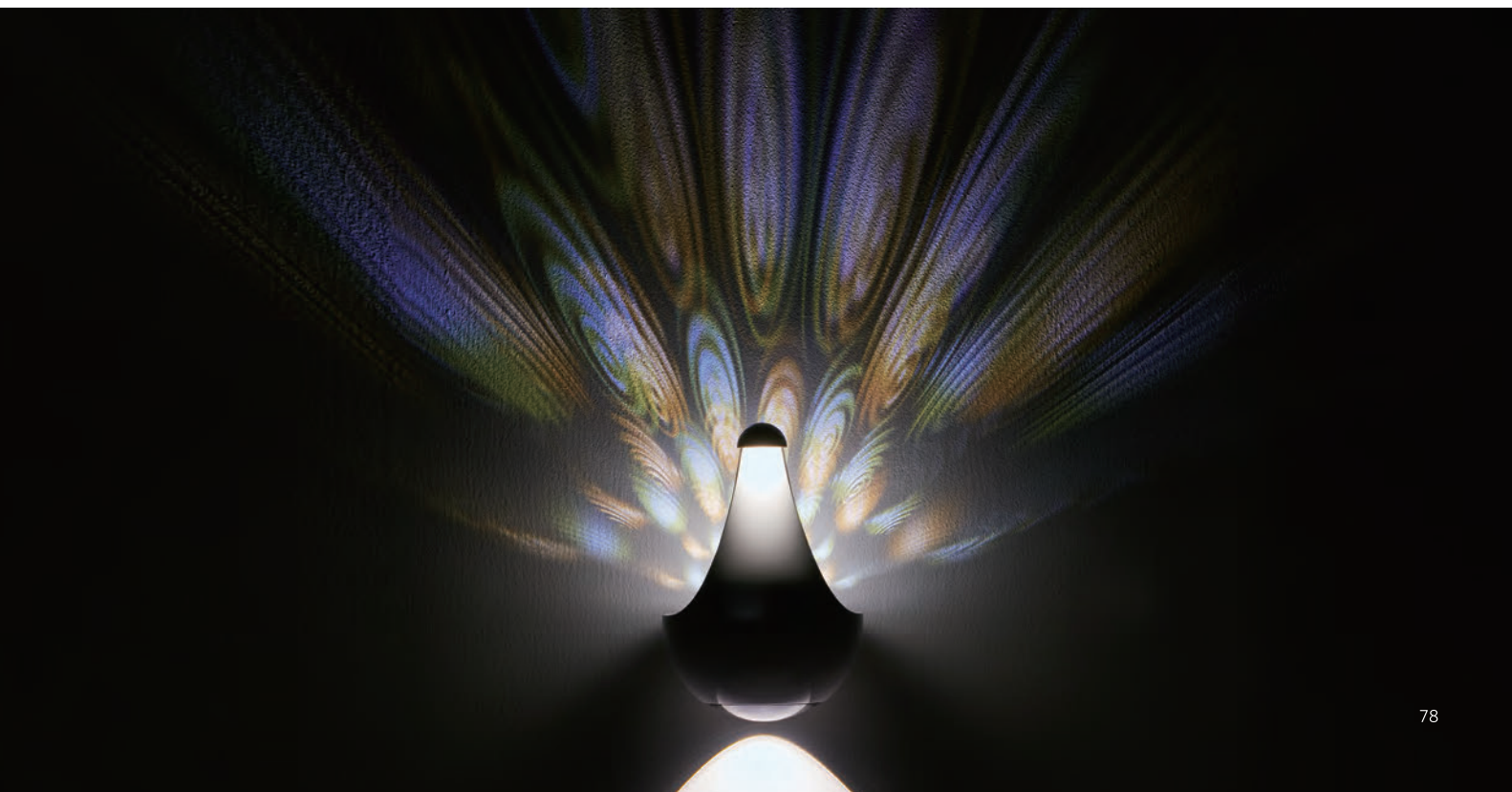

| OTHERS





BACTERICIDAL RATE

UP TO

99.999%

ULTRAVIOLET DISINFECTION **38W**

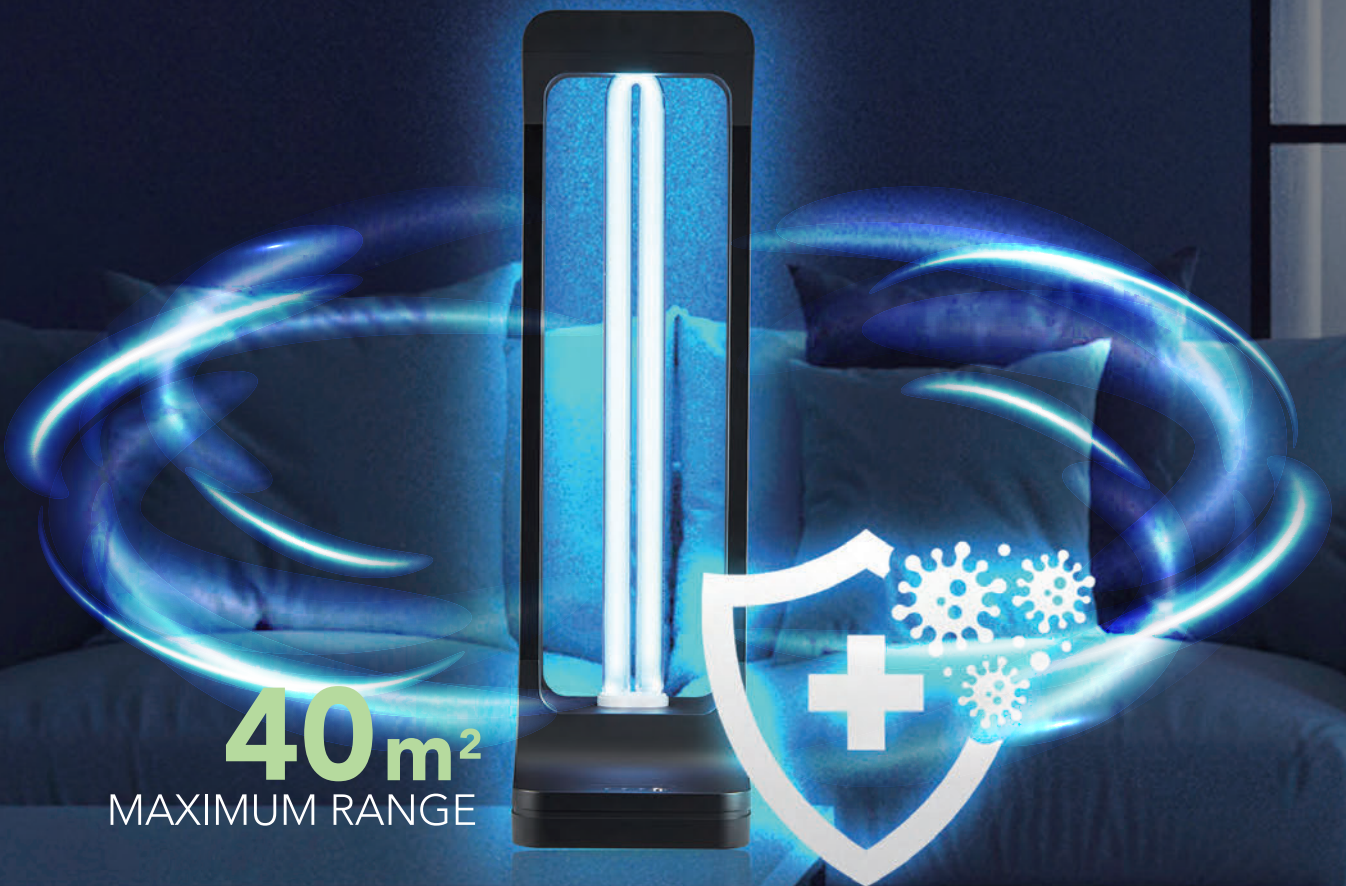

40m²
MAXIMUM RANGE



Order Name	UV Germicidal Lamp
Power	38W
UV Wave(nm)	253.7
UV Intensity(uW/cm ²)	>150
Dimensions	200*140*490mm
Material	ABS+PC+AL+Glass
Timing	15/30/60Min
Remote	Yes
Plug	Type C/Type G

CONTROL THROUGH WALLS

3m
RADAR
SENSOR

10s
DELAY
START

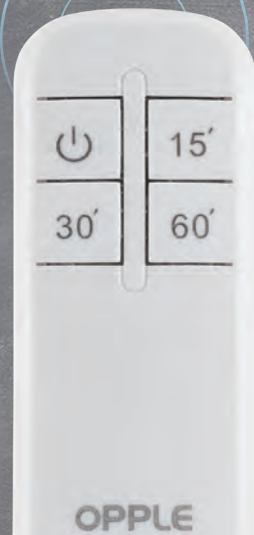

| Switch and Socket



ASP SHIELD SOCKET

* AVOID SINGLE POLE INSERTION DO NOT insert it with violence force.

GUARD YOUR SAFETY



Avoid Single Pole
insertion



High Capacity



850°C Anti-flaming



Instant Wire
Connection



5000 times
of Plugging



40,000 times
On-Off



F01 Series OPPLA ASP Shield Socket / OPPLA Art Switch



AVOID SINGLE POLE INSERTION DO NOT insert it with violence force.

Prevent fingers from touching the metal parts in the socket.
Effectively prevent children from accidental electric shock.



850 °C Anti-flaming

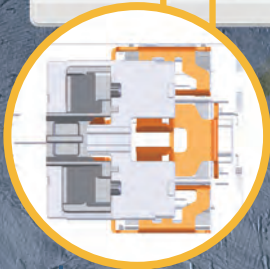

- > Socket shutters can help to shield the metal parts in the socket and prevent electric shock.
- > Keep children safe.



Safe with High flame retardant PC material
Up to 850 °C Anti-flaming PC material
Safety and No deformation



DURABLE AND RELIABLE

16A

High Capacity



40,000 On-Off



5000 times of Plugging

16A high capacity Switch with Red copper & red copper silver coated mechanism parts

Stronger current carrying capacity

Up to 40000 times of Switching

16A high capacity Socket for high-power electrical appliances

Up to 5000 times of plugging



Two color option: **White** and **Grey Black** ● ●



EASY TO FIX

Modular design

Modular design for easy combination of frame and function module.
Function module can match most plates of other brand.

Instant wire connection for easy installation

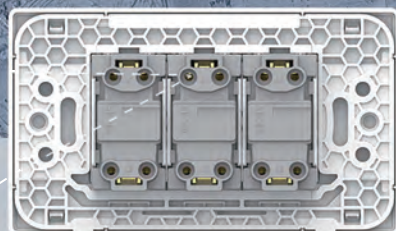
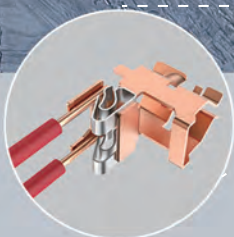

ASP^{*} SHIELD SOCKET

* AVOID SINGLE POLE INSERTION - DO NOT insert it with violence force.

GUARD YOUR SAFETY



Avoid Single Pole insertion



High Capacity



850°C Anti-flaming



5000 times of Plugging



40,000 times On-Off



Edge to Edge



F02 Series OPPLE ASP Shield Socket / OPPLE Art Switch



AVOID SINGLE POLE INSERTION DO NOT insert it with violence force.

Prevent fingers from touching the metal parts in the socket.
Effectively prevent children from accidental electric shock.

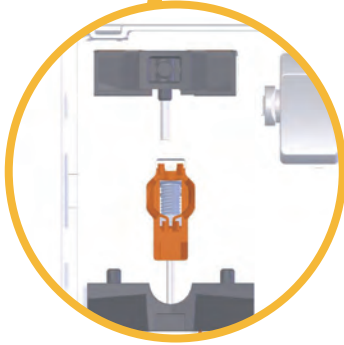

- > Socket shutters can help to shield the metal parts in the socket and prevent electric shock.
- > Keep children safe.



850°C
Anti-flaming

Safe with High flame retardant PC material
Up to 850 C Anti-flaming PC material
Safety and No deformation

DURABLE AND RELIABLE

16A

High Capacity



40,000 On-Off

16A high capacity Switch with Red copper & red copper silver coated mechanism parts

Stronger current carrying capacity

Up to 40000 times of Switching



5000 times of Plugging

16A high capacity Socket for high-power electrical appliances

Up to 5000 times of plugging



Two color option: **White** and **Grey Black** ● ●



2.4A USB port for quick charge

EASY TO USE

- > **Edge to edge design with big button**

Press as you like with comfortable touch

- > **Fluorescent indicator design**

Easy to identify in the dark and no dazzling

| **Breaker**



ZB Series Circuit Breaker

Low Voltage Distribution Products

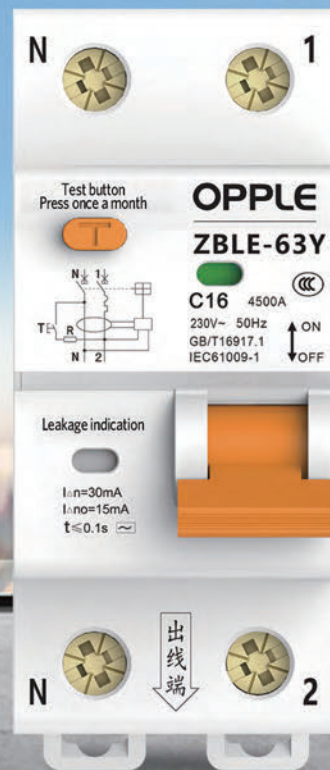
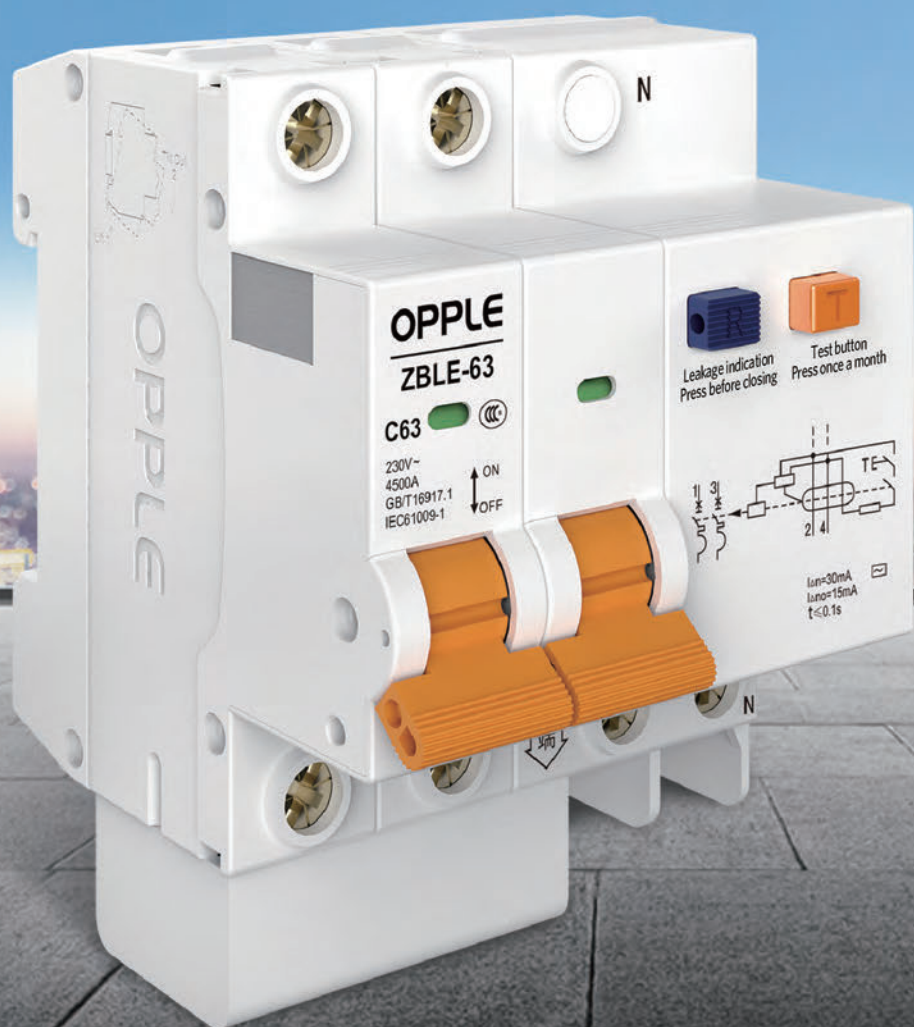

Product list- MCB



1P

2P

3P

4P

Product list- RCBO

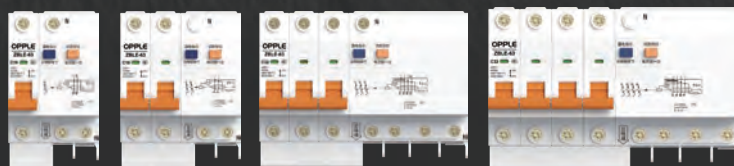

1P+N

2P

3P+N

4P

Features

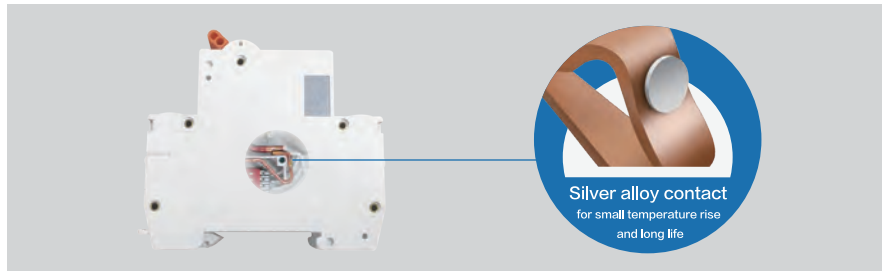

Silver alloy contact
for small temperature rise
and long life

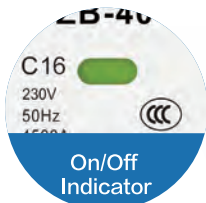

The indicator is green when power is on and change to orange when power is off.



Safety bolt position
for maintenance
safety



Air guide channel
for heat dissipation



Super wide handle
for easy operation



**High strength flame
retardant shell**

Introduction













Summary

Circuit Breaker is used for short circuit, overload and leakage protection of single-phase and three-phase circuits below 125A in single-phase and three-phase circuits. It includes 1P, 2P, 3P, 4P, 1P+N and other mini circuit breakers and leakage protection circuit breakers.

Main parameters and technical performance

Name	Voltage	Connection	Breaking capacity	Ways (1way=18mm)	Function
1P MCB	230V	L	4.5kA	1 Way	Overload and short circuit protection
2P MCB	230V	L+N	4.5kA	2 Way	
3P MCB	400V	L1,L2,L3	4.5kA	3 Way	
4P MCB	400V	L1,L2,L3+N	4.5kA	4 Way	
1P+N RCBO	230V	L+N	4.5kA	3 Way	Overload and short circuit protection The neutral line is only disconnected with handle but don't have protection fuction.
2P RCBO	230V	L+N	4.5kA	4 Way	Overload, short circuit and leakage protection

CEILING LAMP-COMPACT









Series	Picture	SAP code	SAP Information		Key Data					
			Product Description	Model	Rated Voltage(V)	Frequency (Hz)	Power (W)	Lumen (lm)	CCT (K)	Life (h)
Diamond		140067245	LED-HC180-D0.2*30-Diamond-3000K-R-F	LED-HC180-D0.2*30	220-240	50/60	6	400	3000	20000
		140067246	LED-HC180-D0.2*30-Diamond-5700K-R-F	LED-HC180-D0.2*30	220-240	50/60	6	400	5700	20000
Diamond		140067253	LED-HC230-D0.2*60-Diamond-3000K-R-F	LED-HC230-D0.2*60	220-240	50/60	12	850	3000	20000
		140067254	LED-HC230-D0.2*60-Diamond-5700K-R-F	LED-HC230-D0.2*60	220-240	50/60	12	850	5700	20000
Diamond		140067255	LED-HC230-D0.2*60-Diamond-3000K-R-T	LED-HC230-D0.2*60	220-240	50/60	12	850	3000	20000
		140067256	LED-HC230-D0.2*60-Diamond-5700K-R-T	LED-HC230-D0.2*60	220-240	50/60	12	850	5700	20000
Diamond		140067249	LED-HC1818-D0.2*42-Diamond-3000K-S-F	LED-HC1818-D0.2*42	220-240	50/60	9	540	3000	20000
		140067250	LED-HC1818-D0.2*42-Diamond-5700K-S-F	LED-HC1818-D0.2*42	220-240	50/60	9	540	5700	20000
Star-Crown II		520028001310	LED HC260 9.6W 3000K Star-Crown II	LED HC260 9.6W II	220-240	50/60	9.6	800	3000	20000
		520028001110	LED HC260 9.6W 5700K Star-Crown II	LED HC260 9.6W II	220-240	50/60	9.6	800	5700	20000
Star-Sunlight II		520028000810	LED HC260 9.6W 5700K Star-Sunlight II	LED HC260 9.6W II	220-240	50/60	9.6	800	5700	20000
Detector		520028003110	HC260-D0.5-Detector- Mic-10W-5700K	LED HC260 10W DM	220-240	50/60	10	800	5700	20000
Detector		520028002810	HC260-D0.5-Detector-Voice-10W-4000K	LED HC260 10W DV	220-240	50/60	10	800	4000	20000
		520028002910	HC260-D0.5-Detector-Voice-10W-5700K	LED HC260 10W DV	220-240	50/60	10	800	5700	20000
White		140054616	LED HC2020 7.5W 4000K White	LED HC2020 7.5W	220-240	50/60	7.5	500	4000	20000
		140047011	LED HC2020 7.5W 5700K White	LED HC2020 7.5W	220-240	50/60	7.5	500	5700	20000
White		140054617	LED HC3030 15W 2700K White	LED HC3030 15W	220-240	50/60	15	1200	2700	20000
		140054618	LED HC3030 15W 4000K White	LED HC3030 15W	220-240	50/60	15	1200	4000	20000
		140047012	LED HC3030 15W 5700K White	LED HC3030 15W	220-240	50/60	15	1200	5700	20000
White		520033003910	LED Ceiling-U2-Rd200-10W-857-White-GP	LED HC200 10W White	220-240	50/60	10	900	5700	20000
		520033003810	LED Ceiling-U2-Rd260-18W-857-White-GP	LED HC260 18W White	220-240	50/60	18	1500	5700	20000
White		520033003710	LED Ceiling-U2-Rd350-23W-857-White-GP	LED HC350 23W White	220-240	50/60	23	1900	5700	20000

Product Dimension (mm)				Product Weight	Inner Box Size (mm)				Groos Weight	Outer Box Dimension (mm)				Groos Weight	Packing Quantity (pcs)	MOQ
Length	Width	Height	Diameter	kg/pc	Length	Width	Height	Volume (m³)	kg/pc	Length	Width	Height	Volume (m³)	kg/CTN		
/	/	37	Ø180	0.19	189	189	40	0.0014	0.29	415	410	205	0.03488	5.80	20	1000
/	/	37	Ø180	0.19	189	189	40	0.0014	0.29	415	410	205	0.03488	5.80	20	1000
/	/	40	Ø230	0.34	239	239	43	0.0025	0.50	510	440	255	0.05722	10.00	20	1000
/	/	40	Ø230	0.34	239	239	43	0.0025	0.50	510	440	255	0.05722	10.00	20	1000
/	/	40	Ø230	0.34	239	239	43	0.0025	0.50	495	450	260	0.05792	10.00	20	1000
/	/	40	Ø230	0.34	239	239	43	0.0025	0.50	495	450	260	0.05792	10.00	20	1000
180	180	37	/	0.24	189	189	40	0.0014	0.35	415	410	205	0.03488	7.00	20	1000
180	180	37	/	0.24	189	189	40	0.0014	0.35	415	410	205	0.03488	7.00	20	1000
/	/	84	Ø278	0.31	313	88	318	0.0088	0.68	610	498	316	0.09599	6.82	10	600
/	/	84	Ø278	0.31	313	88	318	0.0088	0.68	610	498	316	0.09599	6.82	10	600
/	/	84	Ø278	0.30	280	103	280	0.0081	0.72	642	498	332	0.10615	7.20	10	600
/	/	80	Ø260	0.35	295	82	295	0.0071	0.78	605	430	320	0.08325	7.80	10	600
/	/	80	Ø260	0.35	295	82	295	0.0071	0.78	605	430	320	0.08325	7.80	10	600
/	/	80	Ø260	0.35	295	82	295	0.0071	0.78	605	430	320	0.08325	7.80	10	600
218	218	80	/	0.30	255	74	258	0.0049	0.56	525	390	280	0.05733	5.59	10	600
218	218	80	/	0.34	255	74	258	0.0049	0.55	525	390	280	0.05733	5.46	10	600
300	300	87	/	0.58	374	95	374	0.0133	1.14	600	390	395	0.09243	6.83	6	600
300	300	87	/	0.58	374	95	374	0.0133	1.14	600	390	395	0.09243	6.83	6	600
300	300	87	/	0.58	374	95	374	0.0133	1.14	600	390	395	0.09243	6.83	6	600
/	/	48	Ø200	0.220	230	54	236	0.0029	0.32	480	300	490	0.07056	6.40	20	600
/	/	60	Ø272	0.480	310	64	316	0.0063	0.50	640	345	330	0.07286	5.00	10	600
/	/	66	Ø335	0.850	375	72	381	0.0103	0.88	615	390	400	0.09594	7.04	8	600

CEILING LAMP-BEDROOM

Series	Picture	SAP code	SAP Information		Key Data					
			Product Description	Model	Rated Voltage(V)	Frequency (Hz)	Power (W)	Lumen (lm)	CCT (K)	Life (h)
White		520034012610	LED Ceiling-U2-Rd420-38W-857-White-GP	LED HC420 38W White	220-240	50/60	38	3000	5700	20000
Halo		140051084	HC350 16W 4000K Halo	LED HC350 16W-GP	220-240	50/60	16	1300	4000	20000
		140051083	HC350 16W 5700K Halo	LED HC350 16W-GP	220-240	50/60	16	1300	5700	20000
Star-Attic		140051088	HC350 16W 4000K Star-Attic	LED HC350 16W-GP	220-240	50/60	16	1200	4000	20000
		140051087	HC350 16W 5700K Star-Attic	LED HC350 16W-GP	220-240	50/60	16	1200	5700	20000
Prism		520021000210	LED HC380 18W Prism 4000K	LED HC380 18W Prism	220-240	50/60	18	1300	4000	20000
Star-Diamond		520033003610	LED Ceiling-U2-Rd260-18W-857- -Star Diamond-GP	LED HC260 18W Star Diamond	220-240	50/60	18	1500	5700	20000
Star-Diamond		520033003510	LED Ceiling-U2-Rd350-23W-857- -Star Diamond-GP	LED HC350 23W Star Diamond	220-240	50/60	23	1900	5700	20000
Star-Diamond		520034012510	LED Ceiling-U2-Rd420-38W-857- -Star Diamond-GP	LED HC420 38W Star Diamond	220-240	50/60	38	3000	5700	20000
Star-Diamond		520034012410	LED Ceiling-E2-Rd480-48W-STEP -827/857-Star Diamond-GP	LED HC480 48W DIM Star Diamond	220-240	50/60	48	3700	2700 +5700	20000
Star-Diamond		520022003110	LED HC420 22W 3000/4500K Star Diamond	LED HC420 22W DIM	220-240	50/60	22	1800	3000 /4500	20000
Rosy		520022003010	LED HC420 22W 3000/4500K Rosy	LED HC420 22W DIM	220-240	50/60	22	1800	3000 /4500	20000
Hikari		520024000210	LED HC550 55W Dim Hikari 3000K/5700K	LED HC550 55W Dim Hikari	220-240	50/60	55	3600	3000 +5700	20000
Smart Twinkle		140060291	LED IC518 Dim 5700K Smart Twinkle	LED IC518 ST	220-240	50/60	36	1600	5700 +RGB	15000

CEILING LAMP-LIVING ROOM

Series	Picture	SAP code	SAP Information		Key Data					
			Product Description	Model	Rated Voltage(V)	Frequency (Hz)	Power (W)	Lumen (lm)	CCT (K)	Life (h)
Cloud II		520035008410	LED HC6565 92W 5700K+3000K RG Cloud II	LED HC6565 92W	220-240	50/60	92	6500	3000 +5700	20000
Cloud II		520035008310	LED HC9965 144W 5700K+3000K RG Cloud II	LED HC9965 144W	220-240	50/60	144	10300	3000 +5700	20000
WindyS		525001001600	LED FSD-E-Rd420-24W-857-WH-WindyS-GP	LED FSD-E-Rd420- WindyS	220-240	50/60	54 Lamp 24W Fan 30W	2200	5700	15000
WindyS		525001001500	LED FSD-E-Rd420-36W-STEP-GD-WindyS-GP	LED FSD-E-Rd420- STEP-WindyS	220-240	50/60	66 Lamp 36W Fan 30W	3200	3000 +5700	15000
WindyS		525001001400	LED FSD-E-Rd420-36W-STEP-BKWH-WindyS-GP	LED FSD-E-Rd420- STEP-WindyS	220-240	50/60	66 Lamp 36W Fan 30W	3200	3000 +5700	15000
WindyS		525001001300	LED FSD-E-Rd420-36W-STEP-WH-WindyS-GP	LED FSD-E-Rd420- STEP-WindyS	220-240	50/60	66 Lamp 36W Fan 30W	3200	3000 +5700	15000
WindyS		525002001400	LED FSD-E-Rd480-54W-STEP-WH-WindyS-GP	LED FSD-E-Rd480- STEP-WindyS	220-240	50/60	94 Lamp 54W Fan 40W	3800	3000 +5700	15000
WindyS		525002001300	LED FSD-E-Rd480-54W-STEP-GD-WindyS-GP	LED FSD-E-Rd480- STEP-WindyS	220-240	50/60	94 Lamp 54W Fan 40W	3800	3000 +5700	15000
WindyS		525002001200	LED FSD-E-Rd480-54W-STEP-BK-WindyS-GP	LED FSD-E-Rd480- STEP-WindyS	220-240	50/60	94 Lamp 54W Fan 40W	3800	3000 +5700	15000

Product Dimension (mm)				Product Weight	Inner Box Size (mm)				Groos Weight	Outer Box Dimension (mm)				Groos Weight	Packing Quantity (pcs)	MOQ
Length	Width	Height	Diameter		kg/pc	Length	Width	Height		Volume (m ³)	kg/pc	Length	Width			
/	/	72	Φ410	1,275	440	78	446	0,0153	1,31	660	455	465	0,13964	10,48	8	600
/	/	98	Φ345	0,85	375	103	380	0,0147	1,39	546	390	402	0,08560	6,96	5	500
/	/	98	Φ345	0,73	375	103	380	0,0147	1,39	546	390	402	0,08560	6,96	5	500
/	/	85	Φ380	0,82	425	87	430	0,0159	1,45	566	412	422	0,09841	8,70	6	600
/	/	85	Φ380	0,82	425	87	430	0,0159	1,45	566	412	422	0,09841	8,70	6	600
/	/	90	Φ380	0,958	416	98	416	0,0170	1,97	520	426	438	0,09703	9,83	5	600
/	/	66	Φ272	0,600	310	72	316	0,0071	0,72	640	385	330	0,08131	7,24	10	600
/	/	72	Φ335	0,930	375	78	381	0,0111	1,15	663	390	400	0,10343	9,20	8	600
/	/	74	Φ410	1,340	440	78	446	0,0153	1,53	660	455	465	0,13964	12,24	8	600
/	/	86	Φ480	2,230	537	93	543	0,0271	2,56	555	498	565	0,15616	12,80	5	600
/	/	85	Φ420	0,85	464	466	90	0,0195	1,55	575	480	490	0,13524	9,30	6	600
/	/	85	Φ420	1,16	532	534	90	0,0256	1,95	578	548	561	0,17769	11,71	6	600
/	/	92	Φ616	1,904	/	/	/	/	/	690	690	134	0,06380	3,79	1	600
518	498	105	/	3,50	578	542	115	0,0360	4,31	575	460	570	0,15077	17,25	4	300

Product Dimension (mm)				Product Weight	Inner Box Size (mm)				Groos Weight	Outer Box Dimension (mm)				Groos Weight	Packing Quantity (pcs)	MOQ
Length	Width	Height	Diameter		kg/pc	Length	Width	Height		Volume (m ³)	kg/pc	Length	Width			
650	650	140	/	4,50	/	/	/	/	/	745	745	147	0,08159	6,03	1	600
990	650	140	/	7,55	/	/	/	/	/	1090	745	147	0,11937	11,52	1	600
/	/	300	Φ408 (Sweep Φ910)	4,00	/	/	/	/	/	495	485	228	0,05474	6,50	1	600
/	/	300	Φ430 (Sweep Φ910)	5,60	/	/	/	/	/	495	485	238	0,05714	7,70	1	600
/	/	300	Φ430 (Sweep Φ910)	5,60	/	/	/	/	/	495	485	238	0,05714	7,70	1	600
/	/	300	Φ430 (Sweep Φ910)	5,60	/	/	/	/	/	495	485	238	0,05714	7,70	1	600
/	/	300	Φ505 (Sweep Φ1066)	6,10	/	/	/	/	/	575	575	290	0,09588	8,10	1	600
/	/	300	Φ505 (Sweep Φ1066)	6,10	/	/	/	/	/	575	575	290	0,09588	8,10	1	600
/	/	300	Φ505 (Sweep Φ1066)	6,10	/	/	/	/	/	575	575	290	0,09588	8,10	1	600

MIRROR LAMP-BATHROOM









Series	Picture	SAP code	SAP Information		Key Data					
			Product Description	Model	Rated Voltage(V)	Frequency (Hz)	Power (W)	Lumen (lm)	CCT (K)	Life (h)
Alice		522000001910	LED-HML440-9W-4000K-Alice-CT	LED-HML440-9W-Alice-CT	220-240	50/60	9	600	4000	20000
William		522000002210	LED-HML470-9W-4000K-William-CT	LED-HML470-9W-William-CT	220-240	50/60	9	600	4000	20000
		522000002310	LED-HML470-9W-6500K-William-CT	LED-HML470-9W-William-CT	220-240	50/60	9	600	6500	20000
Xiaobai		140050864	LED HML549 10W 4000K XIAOBAI IBU	LED HML549 10W	220-240	50/60	10	650	4000	1500

TABLE LAMP-READING & WORKING

Series	Picture	SAP code	SAP Information		Key Data					
			Product Description	Model	Rated Voltage(V)	Frequency (Hz)	Power (W)	Lumen (lm)	CCT (K)	Life (h)
Pipe II		523004006210	LED MT 4.8W Dim 4000K White Pipe II	LED MT 4.8W Pipe II	USB DC5V	/	4.8	100(max)	4000	20000
Reader		523006001210	LED MT 5W 4000K Reader	LED MT 5W 4000K Reader	USB DC5V	/	5	200	4000	20000
Toranto		523006002110	LED HTL 7W Dim 4000K Toranto White DZ	LED HTL 7W Dim	220-240	50/60	7	U450	4000	15000
Toranto		523006002210	LED HTL 7W Dim 4000K Toranto Black DZ	LED HTL 7W Dim	220-240	50/60	7	U450	4000	15000
Lotus		140060293	LED-NL-Lotus-W	LED-Lotus	DC4.5 V	/	0.3	14	3000	15000

WALL LAMP-OPTIMAL AMBIENCE

Series	Picture	SAP code	SAP Information		Key Data					
			Product Description	Model	Rated Voltage(V)	Frequency (Hz)	Power (W)	Lumen (lm)	CCT (K)	Life (h)
Peacock		522003006000	MZB120-5.7W-3000K/4000K/5700K-Peacock	LED HWL 120 5.7W	220-240	50/60	5.7	250	3000 +4000 +5700	15000

OTHERS

Series	Picture	SAP code	SAP Information		Key Data					
			Product Description	Model	Rated Voltage(V)	Frequency (Hz)	Power (W)	Lumen (lm)	CCT (K)	Life (h)
UV-Germicidal lamp		523008004700	OP-UV-Germicidal lamp-E 38W-BK-GP(C Plug)	OP-UV-L02	220-240	50/60	38	>150uW/cm ²	253.7nm	8000
		523008004800	OP-UV-Germicidal lamp-E 38W-BK-GP(G Plug)	OP-UV-L02	220-240	50/60	38	>150 uW/cm ²	253.7nm	8000



































Product Dimension (mm)				Product Weight	Inner Box Size (mm)				Groos Weight	Outer Box Dimension (mm)				Groos Weight	Packing Quantity (pcs)	MOQ
Length	Width	Height	Diameter	kg/pc	Length	Width	Height	Volume (m ³)	kg/pc	Length	Width	Height	Volume (m ³)	kg/CTN		
440	70	50	/	0.34	450	80	60	0.0022	0.78	460	340	210	0.03284	9.30	12	2000
470	80	41	/	0.37	480	90	50	0.0022	0.85	490	285	240	0.03352	10.20	12	2000
470	80	41	/	0.37	480	90	50	0.0022	0.85	490	285	240	0.03352	10.20	12	2000
586	64	50	/	0.47	595	70	60	0.0025	0.63	610	300	205	0.03752	7.60	12	600

Product Dimension (mm)				Product Weight	Inner Box Size (mm)				Groos Weight	Outer Box Dimension (mm)				Groos Weight	Packing Quantity (pcs)	MOQ
Length	Width	Height	Diameter	kg/pc	Length	Width	Height	Volume (m ³)	kg/pc	Length	Width	Height	Volume (m ³)	kg/CTN		
121	74	413	/	0.35	155	75	205	0.0024	0.48	640	395	220	0.05562	9.50	20	1000
280	100	100	/	0.49	280	100	100	0.0028	0.63	445	330	305	0.04479	7.56	12	1000
200	156	420	/	1.00	571	166	76	0.0072	1.35	590	255	355	0.05341	8.10	6	1000
200	156	420	/	1.00	571	166	76	0.0072	1.35	590	255	355	0.05341	8.10	6	1000
75	75	18	/	0.07	182	95	20	0.0003	0.10	521	380	114	0.02257	4.85	50	1000

Product Dimension (mm)				Product Weight	Inner Box Size (mm)				Groos Weight	Outer Box Dimension (mm)				Groos Weight	Packing Quantity (pcs)	MOQ
Length	Width	Height	Diameter	kg/pc	Length	Width	Height	Volume (m ³)	kg/pc	Length	Width	Height	Volume (m ³)	kg/CTN		
/	/	117.5	Ø120	0.691	144	130	200	0.0037	0.90	310	310	155	0.01490	3.61	4	1000



























Product Dimension (mm)				Product Weight	Inner Box Size (mm)				Groos Weight	Outer Box Dimension (mm)				Groos Weight	Packing Quantity (pcs)	MOQ
Length	Width	Height	Diameter	kg/pc	Length	Width	Height	Volume (m ³)	kg/pc	Length	Width	Height	Volume (m ³)	kg/CTN		
200	140	490	/	0.94	260	195	520	0.0264	1.73	660	560	540	0.19958	10.37	6	1000
200	140	490	/	0.94	260	195	520	0.0264	1.73	660	560	540	0.19958	10.37	6	1000

SWITCH AND SOCKET-F01 Series

Picture	SAP Information			Key Data		Product Dimension (mm)		
	SAP code	Product Description	Model	Specification	Colour	Length	Width	Height
	600002007900	F011611A-Switch Set-1G1W-WH-GP	F011611A	16AX 250V-	White	120	70	32
	600002005800	F011612A-Switch Set-1G2W-WH-GP	F011612A	16AX 250V-	White	120	70	32
	600002006800	F018401A-Switch Set-Doorbell-1G-WH-GP	F018401A	16A 250V-	White	120	70	32
	600002005700	F011621A-Switch Set-2G1W-WH-GP	F011621A	16AX 250V-	White	120	70	32
	600002006700	F011622A-Switch Set-2G2W-WH-GP	F011622A	16AX 250V-	White	120	70	32
	600002008200	F011631A-Switch Set-3G1W-WH-GP	F011631A	16AX 250V-	White	120	70	32
	600002005600	F011632A-Switch Set-3G2W-WH-GP	F011632A	16AX 250V-	White	120	70	32
	600002007100	F01167U-Outlet set-US-1G-WH-GP	F01167U	16A 250V-	White	120	70	32.0
	600002008100	F01167U2-Outlet Set-US-2G-WH-GP	F01167U2	16A 250V-	White	120	70	32.0
	600002006000	F01207-Outlet Set-AirCon-20A-1G-WH-GP	F01207	20A 250V-	White	120	70	30.0
	600002007000	F011699-Outlet Set-Universe-1G-WH-GP	F011699	10A 250V-	White	120	70	40
	600002008400	F016901-Outlet Set-Computer-1G-WH-GP	F016901	CAT6(6P6C)	White	120	70	35
	600002005900	F016201-Outlet Set-Telephone-1G-WH-GP	F016201	4 pins	White	120	70	35.0
	600002007300	F016101-Outlet Set-F Head TV-1G-WH-GP	F016101	5-850MHZ	White	120	70	35
	600002008300	F016502-Outlet Set-Tel and PC-WH-GP	F016502	4 pins CAT6(6P6C)	White	120	70	35
	600002006200	F018501-Outlet Set-USB-2.4A-WH-GP	F018501	5V 2.4A	White	120	70	42
	600002007200	F018101-Switch Set-Dier-300W-WH-GP	F018101	200-240V- 30-300W	White	120	70	55
	600002008600	F011611A-Switch Set-1G1W-DG-GP	F011611A	16AX 250V-	Dark Gray	120	70	32
	600002006100	F011612A-Switch Set-1G2W-DG-GP	F011612A	16AX 250V-	Dark Gray	120	70	32
	600002007500	F018401A-Switch Set-Doorbell-1G-DG-GP	F018401A	16A 250V-	Dark Gray	120	70	32
	600002008500	F011621A-Switch Set-2G1W-DG-GP	F011621A	16AX 250V-	Dark Gray	120	70	32
	600002006400	F011622A-Switch Set-2G2W-DG-GP	F011622A	16AX 250V-	Dark Gray	120	70	32
	600002007400	F011631A-Switch Set-3G1W-DG-GP	F011631A	16AX 250V-	Dark Gray	120	70	32
	600002008800	F011632A-Switch Set-3G2W-DG-GP	F011632A	16AX 250V-	Dark Gray	120	70	32
	600002006300	F01167U-Outlet Set-US-1G-DG-GP	F01167U	16A 250V-	Dark Gray	120	70	32
	600002007700	F01167U2-Outlet Set-US-2G-DG-GP	F01167U2	16A 250V-	Dark Gray	120	70	32
	600002008700	F01207-Outlet Set-AirCon-20A-1G-DG-GP	F01207	20A 250V-	Dark Gray	120	70	30
	600002006600	F011699-Outlet Set-Universe-1G-DG-GP	F011699	10A 250V-	Dark Gray	120	70	40
	600002007600	F016901-Outlet Set-Computer-1G-DG-GP	F016901	CAT6(6P6C)	Dark Gray	120	70	35
	600002009000	F016201-Outlet Set-Telephone-1G-DG-GP	F016201	4 pins	Dark Gray	120	70	35
	600002006500	F016101-Outlet Set-F Head TV-1G-DG-GP	F016101	5-850MHZ	Dark Gray	120	70	35
	600002008000	F016502-Outlet Set-Tel and PC-DG-GP	F016502	4 pins CAT6(6P6C)	Dark Gray	120	70	35
	600002008900	F018501-Outlet Set-USB-2.4A-DG-GP	F018501	5V 2.4A	Dark Gray	120	70	42
	600002006900	F018101-Switch Set-Dier-300W-DG-GP	F018101	200-240V- 30-300W	Dark Gray	120	70	55



























Product Weight	Inner Box Size (mm)				Gross Weight	Outer Box Dimension (mm)				Gross Weight	Packing Quantity (pcs)	MOQ
	kg/pc	Length	Width	Height		Volume (m ³)	kg/pc	Length	Width			
0.0481	330	130	80	0.0034320	0.0543	420	275	345	0.0398475	5.43	100	1000
0.0619	330	130	80	0.0034320	0.0681	420	275	345	0.0398475	6.81	100	1000
0.0579	330	130	80	0.0034320	0.0641	420	275	345	0.0398475	6.41	100	1000
0.0773	330	130	80	0.0034320	0.0835	420	275	345	0.0398475	8.35	100	1000
0.1049	330	130	80	0.0034320	0.1111	420	275	345	0.0398475	11.11	100	1000
0.0928	330	130	80	0.0034320	0.0990	420	275	345	0.0398475	9.90	100	1000
0.1327	330	130	80	0.0034320	0.1389	420	275	345	0.0398475	13.89	100	1000
0.0776	330	130	80	0.0034320	0.0838	420	275	345	0.0398475	8.38	100	1000
0.0749	330	130	80	0.0034320	0.0811	420	275	345	0.0398475	8.11	100	1000
0.0755	330	130	80	0.0034320	0.0817	420	275	345	0.0398475	8.17	100	1000
0.0782	330	130	80	0.0034320	0.0844	420	275	345	0.0398475	6.75	80	1000
0.0514	330	130	80	0.0034320	0.0576	420	275	345	0.0398475	5.18	90	1000
0.0496	330	130	80	0.0034320	0.0558	420	275	345	0.0398475	5.58	100	1000
0.0522	330	130	80	0.0034320	0.0584	420	275	345	0.0398475	5.84	100	1000
0.0613	330	130	80	0.0034320	0.0675	420	275	345	0.0398475	6.08	90	1000
0.0899	330	130	80	0.0034320	0.0961	420	275	345	0.0398475	6.73	70	1000
0.0975	330	130	80	0.0034320	0.1037	420	275	345	0.0398475	5.19	50	1000
0.0481	330	130	80	0.0034320	0.0543	420	275	345	0.0398475	5.43	100	1000
0.0619	330	130	80	0.0034320	0.0681	420	275	345	0.0398475	6.81	100	1000
0.0579	330	130	80	0.0034320	0.0641	420	275	345	0.0398475	6.41	100	1000
0.0773	330	130	80	0.0034320	0.0835	420	275	345	0.0398475	8.35	100	1000
0.1049	330	130	80	0.0034320	0.1111	420	275	345	0.0398475	11.11	100	1000
0.0928	330	130	80	0.0034320	0.0990	420	275	345	0.0398475	9.90	100	1000
0.1327	330	130	80	0.0034320	0.1389	420	275	345	0.0398475	13.89	100	1000
0.0776	330	130	80	0.0034320	0.0838	420	275	345	0.0398475	8.38	100	1000
0.0749	330	130	80	0.0034320	0.0811	420	275	345	0.0398475	8.11	100	1000
0.0755	330	130	80	0.0034320	0.0817	420	275	345	0.0398475	8.17	100	1000
0.0782	330	130	80	0.0034320	0.0844	420	275	345	0.0398475	6.75	80	1000
0.0514	330	130	80	0.0034320	0.0576	420	275	345	0.0398475	5.18	90	1000
0.0496	330	130	80	0.0034320	0.0558	420	275	345	0.0398475	5.58	100	1000
0.0522	330	130	80	0.0034320	0.0584	420	275	345	0.0398475	5.84	100	1000
0.0613	330	130	80	0.0034320	0.0675	420	275	345	0.0398475	6.08	90	1000
0.0899	330	130	80	0.0034320	0.0961	420	275	345	0.0398475	6.73	70	1000
0.0975	330	130	80	0.0034320	0.1037	420	275	345	0.0398475	5.19	50	1000

F01 Frame&function module

Picture	SAP Information			Key Data		Product Dimension (mm)		
	SAP code	Product Description	Model	Specification	Colour	Length	Width	Height
	600002004700	F015910-Plate-1M-WH-GP	F015910	120*70	White	120	70	8,8
	600002003600	F015920-Plate-2M-WH-GP	F015920	120*70	White	120	70	8,8
	600002003700	F015921-Plate-2X-1M-WH-GP	F015921	120*70	White	120	70	8,8
	600002002700	F015930-Plate-3M-WH-GP	F015930	120*70	White	120	70	8,8
	600002000900	F015940-Plate-4X-1M-WH-GP	F015940	120*116	White	120	120	8,8
	600002001300	F015960-Plate-2X-3M-WH-GP	F015960	120*116	White	120	120	8,8
	600002005200	F01G31A-Switch-1G1W-1M-WH-GP	F01G31A	16AX 250V-	White	25	44	31
	600002003100	F01G32A-Switch-1G2W-1M-WH-GP	F01G32A	16AX 250V-	White	25	44	31
	600002003900	F01G84A-Switch-Doorbell-1M-WH-GP	F01G84A	16A 250V-	White	25	44	31
	600002002900	F01G11A-Switch-1G1W-3M-WH-GP	F01G11A	16AX 250V-	White	70	44	31
	600002000400	F01G12A-Switch-1G2W-3M-WH-GP	F01G12A	16AX 250V-	White	70	44	31
	600002004600	F01G21A-Switch-1G1W-1.5M-WH-GP	F01G21A	16AX 250V-	White	34,5	44	31
	600002005400	F01G22A-Switch-1G2W-1.5M-WH-GP	F01G22A	16AX 250V-	White	34,5	44	31
	600002003300	F01G80-Socket-2 pin-1M-WH-GP	F01G80	16A 250V-	White	23	44	31
	600002001900	F01G7U-Socket-US-3-pin-2M-WH-GP	F01G7U	16A 250V-	White	46	44	29,5
	600002002400	F01G7U2-Socket-US-3-pin-3M-WH-GP	F01G7U2	16A 250V-	White	70	44	29,5
	600002000600	F01G720-Socket-AirCon-3-pin-20A-2M-WH-GP	F01G720	20A 250V-	White	46	44	29,5
	600002004800	F01G99-Socket-Universe-3-pin-2M-WH-GP	F01G99	10A 250V-	White	46	44	40,0
	600002004900	F01G64-Outlet-Computer-1M-WH-GP	F01G64	CAT6(6P6C)	White	23	44	34
	600002004100	F01G62-Outlet-Telephone-1M-WH-GP	F01G62	4 lines	White	23	44	29,5
	600002002100	F01G61-Outlet-TV-1M-WH-GP	F01G61	5-850MHZ	White	23	44	29
	600002002500	F01G61F-Outlet-F Head TV-1M-WH-GP	F01G61F	5-850MHZ	White	23	44	26
	600002001400	F01G85-Outlet-USB-2.4A-2M-WH-GP	F01G85	5V 2.4A	White	46	44	42
	600002004300	F01G81-Switch-Dimmer-300W-2M-WH-GP	F01G81	200-240V- 30-300W	White	46	44	55
	600002005100	F01G541M-Plate-Blank-1M-WH-GP	F01G541M	23x42	White	23	44	9,5
	600002004200	F015910-Plate-1M-DG-GP	F015910	120x70	Dark Gray	120	70	8,8
	600002001700	F015920-Plate-2M-DG-GP	F015920	120x70	Dark Gray	120	70	8,8





























Product Weight	Inner Box Size (mm)				Gross Weight	Outer Box Dimension (mm)				Gross Weight	Packing Quantity (pcs)	MOQ
	kg/pc	Length	Width	Height		Volume (m ³)	kg/pc	Length	Width			
0.0394	130	100	80	0.00104	0.0456	420	215	145	0.0131	4.56	100	1000
0.0389	130	100	80	0.00104	0.0451	420	215	145	0.0131	4.51	100	1000
0.0391	130	100	80	0.00104	0.0453	420	215	145	0.0131	4.53	100	1000
0.0373	130	100	80	0.00104	0.0435	420	215	145	0.0131	4.35	100	1000
0.0573	130	100	130	0.00169	0.0635	670	215	145	0.0209	6.35	100	1000
0.0543	130	100	130	0.00169	0.0605	670	215	145	0.0209	6.05	100	1000
0.0185	135	100	50	0.00068	0.0247	270	215	150	0.0087	2.47	100	1000
0.0318	135	100	50	0.00068	0.0380	270	215	150	0.0087	3.80	100	1000
0.0185	135	100	50	0.00068	0.0247	270	215	150	0.0087	2.47	100	1000
0.0108	170	153	60	0.00156	0.0170	320	320	185	0.0189	1.70	100	1000
0.0246	170	153	60	0.00156	0.0308	320	320	185	0.0189	3.08	100	1000
0.0200	170	153	60	0.00156	0.0262	320	320	185	0.0189	2.62	100	1000
0.0338	170	153	60	0.00156	0.0400	320	320	185	0.0189	4.00	100	1000
0.0218	135	100	50	0.00068	0.0280	270	215	150	0.0087	2.80	100	1000
0.0360	170	153	60	0.00156	0.0422	320	320	185	0.0189	4.22	100	1000
0.0528	170	153	60	0.00156	0.0590	320	320	185	0.0189	5.90	100	1000
0.0366	170	153	60	0.00156	0.0428	320	320	185	0.0189	4.28	100	1000
0.0393	240	70	70	0.00118	0.0517	370	155	255	0.0146	2.59	50	1000
0.0120	135	100	50	0.00068	0.0182	270	215	150	0.0087	1.82	100	1000
0.0102	135	100	50	0.00068	0.0164	270	215	150	0.0087	1.64	100	1000
0.0128	135	100	50	0.00068	0.0190	270	215	150	0.0087	1.90	100	1000
0.0088	135	100	50	0.00068	0.0150	270	215	150	0.0087	1.50	100	1000
0.0510	240	70	70	0.00118	0.0634	370	155	255	0.0146	3.17	50	1000
0.0586	240	70	70	0.00118	0.0710	370	155	255	0.0146	3.55	50	1000
0.0029	135	100	50	0.00068	0.0091	270	215	150	0.0087	1.82	200	1000
0.0394	330	130	80	0.00343	0.0456	420	275	345	0.0398	4.56	100	1000
0.0389	130	95	80	0.00099	0.0451	420	205	145	0.0125	4.51	100	1000

F01 Frame&function module

Picture	SAP Information			Key Data		Product Dimension (mm)		
	SAP code	Product Description	Model	Specification	Colour	Length	Width	Height
	600002000800	F015921-Plate-2X-1M-DG-GP	F015921	120 × 70	Dark Gray	120	70	8,8
	600002001600	F015930-Plate-3M-DG-GP	F015930	120 × 70	Dark Gray	120	70	8,8
	600002004400	F015940-Plate-4X-1M-DG-GP	F015940	120 × 116	Dark Gray	120	120	8,8
	600002003400	F015960-Plate-2X-3M-DG-GP	F015960	120 × 116	Dark Gray	120	120	8,8
	600002003800	F01G31A-Switch-1G1W-1M-DG-GP	F01G31A	16AX 250V~	Dark Gray	25	44	31,0
	600002001800	F01G32A-Switch-1G2W-1M-DG-GP	F01G32A	16AX 250V~	Dark Gray	25	44	31,0
	600002001000	F01G84A-Switch-Doorbell-1M-DG-GP	F01G84A	16A 250V~	Dark Gray	25	44	31,0
	600002001100	F01G11A-Switch-1G1W-3M-DG-GP	F01G11A	16AX 250V~	Dark Gray	70	44	31,0
	600002005300	F01G12A-Switch-1G2W-3M-DG-GP	F01G12A	16AX 250V~	Dark Gray	70	44	31,0
	600002003500	F01G21A-Switch-1G1W-1.5M-DG-GP	F01G21A	16AX 250V~	Dark Gray	34,5	44	31
	600002004000	F01G22A-Switch-1G2W-1.5M-DG-GP	F01G22A	16AX 250V~	Dark Gray	34,5	44	31
	600002002600	F01G80-Socket-2-pin-1M-DG-GP	F01G80	16A 250V~	Dark Gray	23	44	31
	600002000500	F01G7U-Socket-US-3-pin-2M-DG-GP	F01G7U	16A 250V~	Dark Gray	46	44	29,5
	600002001200	F01G7U2-Socket-US-2 × 3-pin-3M-DG-GP	F01G7U2	16A 250V~	Dark Gray	70	44	29,5
	600002005500	F01G720-Socket-Air Con-20A-2M-DG-GP	F01G720	20A 250V~	Dark Gray	46	44	29,5
	600002003000	F01G99-Socket-Universe-2M-DG-GP	F01G99	10A 250V~	Dark Gray	46	44	40
	600002002000	F01G64-Outlet-Computer-1M-DG-GP	F01G64	CAT6(6P6C)	Dark Gray	23	44	34
	600002002800	F01G62-Outlet-Telephone-1M-DG-GP	F01G62	4 lines	Dark Gray	23	44	29,5
	600002000700	F01G61-Outlet-TV-1M-DG-GP	F01G61	5-850MHZ	Dark Gray	23	44	29
	600002004500	F01G61F-Outlet-F Head TV-1M-DG-GP	F01G61F	5-850MHZ	Dark Gray	23	44	26
	600002005000	F01G85-Outlet-USB-2.4A-2M-DG-GP	F01G85	5V 2.4A	Dark Gray	46	44	42
	600002003200	F01G81-Switch-Dimmer-300W-2M -DG-GP	F01G81	200-240V~ 30-300W	Dark Gray	46	44	55
	600002002200	F01G541M-Plate-Blank-1M-DG-GP	F01G541M	23 × 42	Dark Gray	23	44	9,5
	600002002300	F015305-Waterproof Cover-H-GY-GP	F015305	IP55	GY	139	101	35
	600002001500	F015306-Waterproof Cover-V-GY-GP	F015306	IP13	GY	133	75	20
	600002007800	D081096TG-Floor Receptacle-2 × 3-pin-SG-GP	D081096TG	10A 250V~	Silver Gray	120	120	61





























Product Weight	Inner Box Size (mm)				Gross Weight	Outer Box Dimension (mm)				Gross Weight	Packing Quantity (pcs)	MOQ
	kg/pc	Length	Width	Height		Volume (m ³)	kg/pc	Length	Width			
0.0391	130	95	80	0.00099	0.0453	420	205	145	0.0125	4.53	100	1000
0.0373	130	95	80	0.00099	0.0435	420	205	145	0.0125	4.35	100	1000
0.0573	130	95	80	0.00099	0.0635	420	205	145	0.0125	6.35	100	1000
0.0543	130	95	80	0.00099	0.0605	420	205	145	0.0125	6.05	100	1000
0.0185	135	100	50	0.00068	0.0247	270	215	150	0.0087	2.47	100	1000
0.0318	135	100	50	0.00068	0.0380	270	215	150	0.0087	3.80	100	1000
0.0185	135	100	50	0.00068	0.0247	270	215	150	0.0087	2.47	100	1000
0.0108	170	155	60	0.00158	0.0170	320	325	185	0.0192	1.70	100	1000
0.0246	170	155	60	0.00158	0.0308	320	325	185	0.0192	3.08	100	1000
0.0200	170	155	60	0.00158	0.0262	320	325	185	0.0192	2.62	100	1000
0.0338	170	155	60	0.00158	0.0400	320	325	185	0.0192	4.00	100	1000
0.0218	135	100	50	0.00068	0.0280	270	215	150	0.0087	2.80	100	1000
0.0360	170	155	60	0.00158	0.0422	320	325	185	0.0192	4.22	100	1000
0.0528	170	155	60	0.00158	0.0590	320	325	185	0.0192	5.90	100	1000
0.0366	170	155	60	0.00158	0.0428	320	325	185	0.0192	4.28	100	1000
0.0393	240	70	70	0.00118	0.0517	370	155	255	0.0146	2.59	50	1000
0.0120	135	100	50	0.00068	0.0182	270	215	150	0.0087	1.82	100	1000
0.0102	135	100	50	0.00068	0.0164	270	215	150	0.0087	1.64	100	1000
0.0128	135	100	50	0.00068	0.0190	270	215	150	0.0087	1.90	100	1000
0.0088	135	100	50	0.00068	0.0150	270	215	150	0.0087	1.50	100	1000
0.0510	240	70	70	0.00118	0.0634	370	155	255	0.0146	3.17	50	1000
0.0586	240	70	70	0.00118	0.0710	370	155	255	0.0146	3.55	50	1000
0.0029	135	100	50	0.00068	0.0091	270	215	150	0.0087	1.82	200	1000
0.1512	175	150	110	0.00289	0.1636	570	315	190	0.0341	8.18	50	1000
0.0925	175	150	110	0.00289	0.1003	565	315	190	0.0338	8.02	80	1000
0.9888	150	150	100	0.00225	1.1685	520	315	165	0.0270	11.69	10	1000

SWITCH AND SOCKET-F02 Series

Picture	SAP Information			Key Data		Product Dimension (mm)		
	SAP code	Product Description	Model	Specification	Colour	Length	Width	Height
	600000249400	F021611A-Switch-1G1W-16A-WH-GP	F021611A	16AX 250V-	White	86	88	40
	600000248300	F021612A-Switch-1G2W-16A-WH-GP	F021612A	16AX 250V-	White	86	88	40
	600000247600	F021621A-Switch-2G1W-16A-WH-GP	F021621A	16AX 250V-	White	86	88	40
	600000247700	F021622A-Switch-2G2W-16A-WH-GP	F021622A	16AX 250V-	White	86	88	40
	600000246600	F021631A-Switch-3G1W-16A-WH-GP	F021631A	16AX 250V-	White	86	88	40
	600000250100	F021632A-Switch-3G2W-16A-WH-GP	F021632A	16AX 250V-	White	86	88	40
	600000248900	F021641A-Switch-4G1W-16A-WH-GP	F021641A	16AX 250V-	White	86	88	40
	600000249700	F021642A-Switch-4G2W-16A-WH-GP	F021642A	16AX 250V-	White	86	88	40
	600000247200	F028401A-Switch-Doorbell-16A-WH-GP	F028401A	16A 250V-	White	86	88	40
	600000246100	F022013A-Switch-Neon-2 Pole-20A-WH-GP	F022013A	20A 250V-	White	86	88	25
	600000246400	F024513A-Switch-Neon-2 Pole-45A-WH-GP	F024513A	45A 250V-	White	86	88	30
	600000251000	F021371A-Switched SKT-Neon-BS-13A-WH-GP	F021371A	13A 250V-	White	86	88	30
	600000248600	F021374A-Switched SKT-Neon-BS-13A-WH-GP	F021374A	13A 250V-	White	86	88	30
	600000247400	F021572A-Switched SKT-Neon-R-3P15A-WH-GP	F021572A	15A 250V-	White	86	88	35
	600000247900	F021691A-Switched SKT-Neon-GL-3P16A-WH-GP	F021691A	16A 250V-	White	86	88	35
	600000245700	F021681A-Switched SKT-GL-5P-16A-WH-GP	F021681A	16A 250V-	White	86	88	35
	600000250600	F021682A-Switched SKT-1G2W-GL-5P16A-WH-GP	F021682A	16AX 250V- /16A 250V-	White	86	88	35
	600000250900	F021685-Switched SKT-USB-GL-5P-16A-WH-GP	F021685	16A 250V- 2.4A 5V	White	86	88	39
	600000249900	F02167G-Switch-Schuko-16A-WH-GP	F02167G	16A 250V-	White	86	88	39
	600000246900	F026201-Telephone Outlet-WH-GP	F026201	4 lines	White	86	88	35
	600000245900	F026401-Computer Outlet-WH-GP	F026401	CAT6(6P6C)	White	86	88	35
	600000246200	F026101-TV Outlet-WH-GP	F026101	5-850MHZ	White	86	88	29
	600000251100	F026502-Tel+Computer Outlet-WH-GP	F026502	4 lines CAT6(6P6C)	White	86	88	35
	600000249000	F026501-TV+computer Outlet-WH-GP	F026501	5-850MHZ CAT6(6P6C)	White	86	88	35
	600000249500	F026402-Computer Outlet-2G-WH-GP	F026402	CAT6(6P6C)	White	86	88	35
	600000248400	F025401-Blank-WH-GP	F025401		White	86	88	14
	600000245800	F028101-Dimmer Switch-630W-WH-GP	F028101	630W 250V-	White	86	88	43
	600000250300	F028201-Fan Control-300W-WH-GP	F028201	300W 250V-	White	86	88	43
	600000250700	F023067-Key Card Switch-20A-WH-GP	F023067	20A 250V-	White	86	88	44







Product Weight	Inner Box Size (mm)				Gross Weight	Outer Box Dimension (mm)				Gross Weight	Packing Quantity (pcs)	MOQ
	kg/pc	Length	Width	Height		Volume (m ³)	kg/pc	Length	Width			
0.0671	195	160	100	0.00312	0.0848	510	340	210	0.036414	8.479	100	1000
0.0696	195	160	100	0.00312	0.0873	510	340	210	0.036414	8.732	100	1000
0.0819	195	160	100	0.00312	0.0996	510	340	210	0.036414	9.960	100	1000
0.0852	195	160	100	0.00312	0.1029	510	340	210	0.036414	10.286	100	1000
0.0950	195	160	100	0.00312	0.1127	510	340	210	0.036414	11.266	100	1000
0.1004	195	160	100	0.00312	0.1181	510	340	210	0.036414	11.813	100	1000
0.1018	195	160	100	0.00312	0.1195	510	340	210	0.036414	11.952	100	1000
0.1096	195	160	100	0.00312	0.1273	510	340	210	0.036414	12.730	100	1000
0.0681	195	160	100	0.00312	0.0858	510	340	210	0.036414	8.577	100	1000
0.0822	195	160	100	0.00312	0.0999	510	340	210	0.036414	9.985	100	1000
0.1192	195	160	100	0.00312	0.1369	510	340	210	0.036414	13.689	100	1000
0.0824	195	160	100	0.00312	0.1001	510	340	210	0.036414	10.009	100	1000
0.0835	195	160	100	0.00312	0.1012	510	340	210	0.036414	10.122	100	1000
0.0813	195	160	100	0.00312	0.0990	510	340	210	0.036414	9.901	100	1000
0.0762	195	160	100	0.00312	0.0939	510	340	210	0.036414	9.390	100	1000
0.0840	195	160	100	0.00312	0.1016	510	340	210	0.036414	10.164	100	1000
0.0879	195	160	100	0.00312	0.1056	510	340	210	0.036414	10.561	100	1000
0.1039	195	160	100	0.00312	0.1251	510	340	210	0.036414	10.012	80	1000
0.0754	195	160	100	0.00312	0.0966	510	340	210	0.036414	7.730	80	1000
0.0544	195	160	100	0.00312	0.0721	510	340	210	0.036414	7.213	100	1000
0.0548	195	160	100	0.00312	0.0725	510	340	210	0.036414	7.250	100	1000
0.0582	195	160	100	0.00312	0.0759	510	340	210	0.036414	7.586	100	1000
0.0580	195	160	100	0.00312	0.0757	510	340	210	0.036414	7.569	100	1000
0.0630	195	160	100	0.00312	0.0806	510	340	210	0.036414	8.064	100	1000
0.0584	195	160	100	0.00312	0.0761	510	340	210	0.036414	7.607	100	1000
0.0376	195	160	100	0.00312	0.0482	510	340	210	0.036414	9.647	200	1000
0.0910	195	160	100	0.00312	0.1122	510	340	210	0.036414	8.979	80	1000
0.0917	195	160	100	0.00312	0.1129	510	340	210	0.036414	9.031	80	1000
0.1207	195	160	100	0.00312	0.1419	510	340	210	0.036414	11.352	80	1000

SWITCH AND SOCKET-F02 Series

Picture	SAP Information			Key Data		Product Dimension (mm)		
	SAP code	Product Description	Model	Specification	Colour	Length	Width	Height
	600000249600	F021611A-Switch-1G1W-16A-GD-GP	F021611A	16AX 250V-	Gold	86	88	40
	600000247000	F021612A-Switch-1G2W-16A-GD-GP	F021612A	16AX 250V-	Gold	86	88	40
	600000248000	F021621A-Switch-2G1W-16A-GD-GP	F021621A	16AX 250V-	Gold	86	88	40
	600000246800	F021622A-Switch-2G2W-16A-GD-GP	F021622A	16AX 250V-	Gold	86	88	40
	600000250200	F021631A-Switch-3G1W-16A-GD-GP	F021631A	16AX 250V-	Gold	86	88	40
	600000249100	F021632A-Switch-3G2W-16A-GD-GP	F021632A	16AX 250V-	Gold	86	88	40
	600000249200	F021641A-Switch-4G1W-16A-GD-GP	F021641A	16AX 250V-	Gold	86	88	40
	600000248200	F021642A-Switch-4G2W-16A-GD-GP	F021642A	16AX 250V-	Gold	86	88	40
	600000245600	F028401A-Switch-Doorbell-16A-GD-GP	F028401A	16A 250V-	Gold	86	88	40
	600000250400	F022013A-Switch-Neon-2 Pole-20A-GD-GP	F022013A	20A 250V-	Gold	86	88	25
	600000251200	F024513A-Switch-Neon-2 Pole-45A-GD-GP	F024513A	45A 250V-	Gold	86	88	30
	600000248700	F021371A-Switched SKT-Neon-BS-13A-GD-GP	F021371A	13A 250V-	Gold	86	88	30
	600000247500	F021374A-Switched SKT-Neon-BS-13A-GD-GP	F021374A	13A 250V-	Gold	86	88	30
	600000248100	F021572A-Switched SKT-Neon-R-3P15A-GD-GP	F021572A	15A 250V-	Gold	86	88	35
	600000246500	F021691A-Switched SKT-Neon-GL-3P16A-GDGP	F021691A	16A 250V-	Gold	86	88	35
	600000250000	F021681A-Switched SKT-GL-5P-16A-GD-GP	F021681A	16A 250V-	Gold	86	88	35
	600000248800	F021682A-Switched SKT-1G2W-GL-5P16A-GDGP	F021682A	16AX 250V- /16A 250V-	Gold	86	88	35
	600000249300	F021685-Switched SKT-2USB-GL-5P16A-GD-GP	F021685	16A 250V- 2.4A 5V	Gold	86	88	39
	600000247100	F02167G-Switch-Schuko-16A-GD-GP	F02167G	16A 250V-	Gold	86	88	39
	600000246000	F026201-Telephone Outlet-GD-GP	F026201	4 lines	Gold	86	88	35
	600000246300	F026401-Computer Outlet-GD-GP	F026401	CAT6(6P6C)	Gold	86	88	35
	600000251300	F026101-TV Outlet-GD-GP	F026101	5-850MHZ	Gold	86	88	29
	600000248500	F026502-Tel+Computer Outlet-GD-GP	F026502	4 lines CAT6(6P6C)	Gold	86	88	35
	600000247300	F026501-TV+compter Outlet-GD-GP	F026501	5-850MHZ CAT6(6P6C)	Gold	86	88	35
	600000247800	F026402-Computer Outlet-2G-GD-GP	F026402	CAT6(6P6C)	Gold	86	88	35
	600000246700	F025401-Blank-GD-GP	F025401		Gold	86	88	14
	600000250500	F028101-Dimmer Switch-630W-GD-GP	F028101	630W 250V-	Gold	86	88	43
	600000250800	F028201-Fan Control-300W-GD-GP	F028201	300W 250V-	Gold	86	88	43
	600000249800	F023067-Key Card Switch-20A-GD-GP	F023067	20A 250V-	Gold	86	88	44

Product Weight	Inner Box Size (mm)				Gross Weight	Outer Box Dimension (mm)				Gross Weight	Packing Quantity (pcs)	MOQ
	kg/pc	Length	Width	Height		Volume (m ³)	kg/pc	Length	Width			
0.0671	195	160	100	0.00312	0.0848	510	340	210	0.036414	8.479	100	1000
0.0696	195	160	100	0.00312	0.0873	510	340	210	0.036414	8.732	100	1000
0.0819	195	160	100	0.00312	0.0996	510	340	210	0.036414	9.960	100	1000
0.0852	195	160	100	0.00312	0.1029	510	340	210	0.036414	10.286	100	1000
0.0950	195	160	100	0.00312	0.1127	510	340	210	0.036414	11.266	100	1000
0.1004	195	160	100	0.00312	0.1181	510	340	210	0.036414	11.813	100	1000
0.1018	195	160	100	0.00312	0.1195	510	340	210	0.036414	11.952	100	1000
0.1096	195	160	100	0.00312	0.1273	510	340	210	0.036414	12.730	100	1000
0.0681	195	160	100	0.00312	0.0858	510	340	210	0.036414	8.577	100	1000
0.0822	195	160	100	0.00312	0.0999	510	340	210	0.036414	9.985	100	1000
0.1192	195	160	100	0.00312	0.1369	510	340	210	0.036414	13.689	100	1000
0.0824	195	160	100	0.00312	0.1001	510	340	210	0.036414	10.009	100	1000
0.0835	195	160	100	0.00312	0.1012	510	340	210	0.036414	10.122	100	1000
0.0813	195	160	100	0.00312	0.0990	510	340	210	0.036414	9.901	100	1000
0.0762	195	160	100	0.00312	0.0939	510	340	210	0.036414	9.390	100	1000
0.0840	195	160	100	0.00312	0.1016	510	340	210	0.036414	10.164	100	1000
0.0879	195	160	100	0.00312	0.1056	510	340	210	0.036414	10.561	100	1000
0.1039	195	160	100	0.00312	0.1251	510	340	210	0.036414	10.012	80	1000
0.0754	195	160	100	0.00312	0.0966	510	340	210	0.036414	7.730	80	1000
0.0544	195	160	100	0.00312	0.0721	510	340	210	0.036414	7.213	100	1000
0.0548	195	160	100	0.00312	0.0725	510	340	210	0.036414	7.250	100	1000
0.0582	195	160	100	0.00312	0.0759	510	340	210	0.036414	7.586	100	1000
0.0580	195	160	100	0.00312	0.0757	510	340	210	0.036414	7.569	100	1000
0.0630	195	160	100	0.00312	0.0806	510	340	210	0.036414	8.064	100	1000
0.0584	195	160	100	0.00312	0.0761	510	340	210	0.036414	7.607	100	1000
0.0376	195	160	100	0.00312	0.0482	510	340	210	0.036414	9.647	200	1000
0.0910	195	160	100	0.00312	0.1122	510	340	210	0.036414	8.979	80	1000
0.0917	195	160	100	0.00312	0.1129	510	340	210	0.036414	9.031	80	1000
0.1207	195	160	100	0.00312	0.1419	510	340	210	0.036414	11.352	80	1000

ZB Breaker

Picture	SAP Information			Key Data				
	SAP code	Product Description	Model	Ways	Voltage	Rated Current	Rated Service Breaking Capacity	
	601000003000	ZB-63C10-1P-breaker	ZB-63	1P	230V	10A	4500A	0.086
	601000002100	ZB-63C16-1P-breaker	ZB-63	1P	230V	16A	4500A	0.086
	601000002800	ZB-63C20-1P-breaker	ZB-63	1P	230V	20A	4500A	0.089
	601000003200	ZB-63C25-1P-breaker	ZB-63	1P	230V	25A	4500A	0.089
	601000002900	ZB-63C32-1P-breaker	ZB-63	1P	230V	32A	4500A	0.089
	601000002700	ZB-63C40-1P-breaker	ZB-63	1P	230V	40A	4500A	0.091
	601000002500	ZB-63C63-1P-breaker	ZB-63	1P	230V	63A	4500A	0.095
	601000001700	ZB-63C16-2P-breaker	ZB-63	2P	230V	16A	4500A	0.181
	601000003100	ZB-63C20-2P-breaker	ZB-63	2P	230V	20A	4500A	0.181
	601000001900	ZB-63C25-2P-breaker	ZB-63	2P	230V	25A	4500A	0.181
	601000002200	ZB-63C32-2P-breaker	ZB-63	2P	230V	32A	4500A	0.181
	601000002300	ZB-63C40-2P-breaker	ZB-63	2P	230V	40A	4500A	0.181
	601000001500	ZB-63C63-2P-breaker	ZB-63	2P	230V	63A	4500A	0.19
	601000001600	ZB-63C32-3P-breaker	ZB-63	3P	400V	32A	4500A	0.267
	601000002400	ZB-63C40-3P-breaker	ZB-63	3P	400V	40A	4500A	0.273
	601000002000	ZB-63C63-3P-breaker	ZB-63	3P	400V	63A	4500A	0.285
	601000001800	ZB-63C32-4P-breaker	ZB-63	4P	400V	32A	4500A	0.356
	601000002600	ZB-63C40-4P-breaker	ZB-63	4P	400V	40A	4500A	0.364
	601000001400	ZB-63C63-4P-breaker	ZB-63	4P	400V	63A	4500A	0.38
	601001004600	ZBLE-63C16-1P+N-leakage circuit breaker	ZBLE-63	1P+N	230V	16A	4500A	0.229
	601001004100	ZBLE-63C20-1P+N-leakage circuit breaker	ZBLE-63	1P+N	230V	20A	4500A	0.229
	601001005300	ZBLE-63C25-1P+N-leakage circuit breaker	ZBLE-63	1P+N	230V	25A	4500A	0.229
	601001004000	ZBLE-63C32-1P+N-leakage circuit breaker	ZBLE-63	1P+N	230V	32A	4500A	0.229
	601001004700	ZBLE-63C40-1P+N-leakage circuit breaker	ZBLE-63	1P+N	230V	40A	4500A	0.229
	601001004800	ZBLE-63C63-1P+N-leakage circuit breaker	ZBLE-63	1P+N	230V	63A	4500A	0.23
	601001004500	ZBLE-63C32-2P-leakage circuit breaker	ZBLE-63	2P	230V	32A	4500A	0.322
	601001004300	ZBLE-63C40-2P-leakage circuit breaker	ZBLE-63	2P	230V	40A	4500A	0.322
	601001005000	ZBLE-63C63-2P-leakage circuit breaker	ZBLE-63	2P	230V	63A	4500A	0.327

Product Dimension (mm)			Product Weight	Inner Box Size (mm)				Groos Weight	Outer Box Dimension (mm)				Groos Weight	Packing Quantity (pcs)	MOQ
Length	Width	Height		kg/pc	Length	Width	Height		Volume (m ³)	kg/pc	Length	Width			
80	18	72	0.086	222	80	78	0.00138528	0.104	430	235	175	0.01768375	12.48	120	240
80	18	72	0.086	222	80	78	0.00138528	0.104	430	235	175	0.01768375	12.48	120	240
80	18	72	0.089	222	80	78	0.00138528	0.104	430	235	175	0.01768375	12.48	120	240
80	18	72	0.089	222	80	78	0.00138528	0.104	430	235	175	0.01768375	12.48	120	240
80	18	72	0.089	222	80	78	0.00138528	0.104	430	235	175	0.01768375	12.48	120	240
80	18	72	0.091	222	80	78	0.00138528	0.104	430	235	175	0.01768375	12.48	120	240
80	18	72	0.095	222	80	78	0.00138528	0.104	430	235	175	0.01768375	12.48	120	240
80	36	72	0.181	222	80	78	0.00138528	0.208	430	235	175	0.01768375	12.48	60	240
80	36	72	0.181	222	80	78	0.00138528	0.208	430	235	175	0.01768375	12.48	60	240
80	36	72	0.181	222	80	78	0.00138528	0.208	430	235	175	0.01768375	12.48	60	240
80	36	72	0.181	222	80	78	0.00138528	0.208	430	235	175	0.01768375	12.48	60	240
80	36	72	0.181	222	80	78	0.00138528	0.208	430	235	175	0.01768375	12.48	60	240
80	36	72	0.19	222	80	78	0.00138528	0.208	430	235	175	0.01768375	12.48	60	240
80	54	72	0.267	222	80	78	0.00138528	0.312	430	235	175	0.01768375	12.48	40	240
80	54	72	0.273	222	80	78	0.00138528	0.312	430	235	175	0.01768375	12.48	40	240
80	54	72	0.285	222	80	78	0.00138528	0.312	430	235	175	0.01768375	12.48	40	240
80	72	72	0.356	222	80	78	0.00138528	0.416	430	235	175	0.01768375	12.48	30	240
80	72	72	0.364	222	80	78	0.00138528	0.416	430	235	175	0.01768375	12.48	30	240
80	72	72	0.38	222	80	78	0.00138528	0.416	430	235	175	0.01768375	12.48	30	240
94	53.5	72	0.229	222	98	84	0.001827504	0.25	420	235	270	0.026649	12.00	48	240
94	53.5	72	0.229	222	98	84	0.001827504	0.25	420	235	270	0.026649	12.00	48	240
94	53.5	72	0.229	222	98	84	0.001827504	0.25	420	235	270	0.026649	12.00	48	240
94	53.5	72	0.229	222	98	84	0.001827504	0.25	420	235	270	0.026649	12.00	48	240
94	53.5	72	0.229	222	98	84	0.001827504	0.25	420	235	270	0.026649	12.00	48	240
94	53.5	72	0.23	222	98	84	0.001827504	0.25	420	235	270	0.026649	12.00	48	240
94	71.5	72	0.322	222	98	84	0.001827504	0.361	420	235	270	0.026649	13.00	36	240
94	71.5	72	0.322	222	98	84	0.001827504	0.361	420	235	270	0.026649	13.00	36	240
94	71.5	72	0.327	222	98	84	0.001827504	0.361	420	235	270	0.026649	13.00	36	240

OPPLE

OPPLE LIGHTING CO., LTD.

V2-V3 Building, The MIXC, Lane 1799, Wuzhong Road,
Minhang District, Shanghai, China. 201103

OPPLE.COM

